



GLASS ROOMS



CANOPIES



VERANDAS



PERGOLAS



AWNINGS

UMBRELLAS



MILWOOD GROUP

The UK's No 1 Provider of Outdoor Living Solutions

# Product Brochure



# Contents

## **The Glass Room Range 4**

<i>The Contemporary Glass Room</i>	6-7
<i>The Lifestyle Glass Room</i>	8-9
<i>The Traditional Glass Room</i>	10-11
<i>The Simplicity Glass Room</i>	12-13
<i>The Bioclimatic Glass Room</i>	14-15

## **The Alfresco Range 16**

<i>The Contemporary Alfresco</i>	18-23
<i>The Lifestyle Alfresco</i>	24-29
<i>The Traditional Alfresco</i>	30-35

## **The Simplicity Range 36**

<i>The Simplicity 6</i>	38-43
<i>The Simplicity 16</i>	44-49
<i>The Simplicity 35</i>	50-55

## **Heating & Lighting**

<i>Infrared Outdoor Heaters</i>	56
<i>Modular Heaters / LED Lights</i>	57

## **Rafter Bar 58**

## **Bioclimatic Pergola Range 60**

<i>The Reference Pergola</i>	62-63
<i>The Elegance Pergola</i>	64-65
<i>Pergola Accessories</i>	66-67

## **Retractable Verandas 68**

<i>The Mini 90</i>	70-73
<i>The Skipper Plus 500</i>	74-77
<i>The Pergolino</i>	78-79

## **The Awning Range 80**

<i>The Palladio Awning</i>	82-83
<i>The Nordic Awning</i>	84-85
<i>The Heston Awning</i>	86-93
<i>The Apollo Awning</i>	94-95
<i>Screener Veranda</i>	96
<i>Screener Veranda Colours</i>	97
<i>Window Awnings</i>	98
<i>Standard Fabric Colours</i>	99

The content is the most current at the time of printing however Milwood Group have the right to change any specification at all times without prior notice. This is our policy of continual improvement.

## **The Umbrella Range 1**

<i>Classic Umbrellas</i>	102
<i>Giant Umbrellas</i>	104
<i>StrongWind Umbrellas</i>	106
<i>Cantilever Umbrellas</i>	108
<i>Impressive Umbrellas</i>	110
<i>Marine Upgrade</i>	112
<i>Membrane and Fabrics</i>	114
<i>Frame / Coating / Decoral Coating</i>	
<i>Rain Gutters</i>	
<i>Side Sheets</i>	
<i>Heating and Lighting</i>	
<i>Fixings</i>	

## **Accessories 1**

<i>Pavement Banners</i>	122
<i>Simplicity Grass</i>	124

## **General Information 1**

<i>Seamless Integration</i>	
<i>How We Work</i>	
<i>Glass &amp; Glazing Federation (GGF)</i>	
<i>BBSA</i>	
<i>Product Configurator</i>	

# About us

The UK's No 1 Provider of  
Outdoor Living Solutions

The Milwood Group manufacture and supply the highest quality outdoor living solutions to both large and small companies within the home improvement and the fenestration industry.

With over 25 years of experience within the industry, we can provide you with specialist knowledge and competitively priced products suited to any of your clients' needs.

Our customers include manufacturers and installation companies who wish to provide their commercial or domestic customers with high quality, yet cost conscious shade and shelter products.

As part of our service we offer easy to follow installation guides, downloadable marketing material for your sales team and technical drawings for Architects and Designers to make specifying our products simple.

*"I wanted to write and compliment you and your company. Very rarely does one come across a properly structured organisation like yours. Well done - we hope we can do justice to you."*

---

**MARTIN GREEN, LIVING SPACES DIRECT (TRADE PARTNER)**

# The *Glass Room Range*

**When it comes to making the garden a part of your customers home, our glass rooms are perfect in terms of style, design and versatility. Using our unique designs, we are sure to have a system to offer that will be in-keeping with the appearance and function that your customers are looking to achieve and within an affordable budget.**

Our retractable glass sliding doors or fixed glass panels will offer unbroken panoramic views of the surroundings and protect those underneath from the elements, opening your home up to the 'outdoor living indoor' experience.

A glass room allows users to enjoy the outside all year

round and will become the heart of any home.

Each system is individually designed and manufactured to reflect your customers aspirations and requirements, as well as to maximise the space that they have available.

Glass rooms also add value to properties as well as style and character no matter where they are situated within the UK.

All our glass rooms are constructed from aluminium profiles which can be powder coated to any colour and covered with toughened glass roof panels. We also offer shading solutions as well as optional heating and lighting which can transform the outdoors into an area that can be used all year round.



# 5 systems



*The Contemporary*  
Glass Room



*The Lifestyle*  
Glass Room



*The Traditional*  
Glass Room

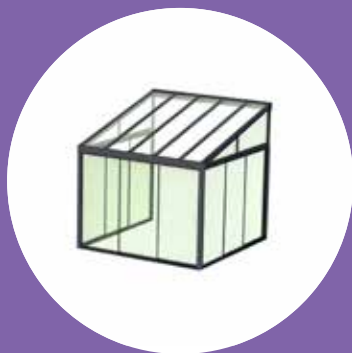

*The Simplicity 6*  
Glass Room



*Bioclimatic*  
Glass Room





# The *Contemporary* Glass Room

**This uniquely designed Glass Room will offer both style and elegance to any property. When incorporating Glass Sliding Doors or Glass Infill Panels, all year round weather protection will be provided allowing the end user to enjoy their outdoor living experience.**

The Contemporary Glass Room will become the focal point of any home, permitting your customers to plan their entertaining or outdoor dining without fear of any disruption from the UK variable weather.

The contemporary design can be further enhanced with the introduction of integrated LED lighting which can change the mood and ambience of the alfresco living experience.

Further additions of heaters will also offer greater functionality on those chilly evenings, whilst the fitting of a Screener Veranda will provide all the sun protection the average family will need.

With a 6m span between posts, it will ensure the panoramic views of the surroundings are completely uncompromised.

All the framework is aluminium and has the option of being powder coating to match any RAL colour and features 8mm toughened clear glass in the roof.

*"Having updated all of our windows and created an area for bi-folding doors, we were looking for a veranda to let us use the garden area all year round and bring the outside in. We didn't want a traditional looking veranda so when we saw the contemporary alfresco, it suited the house perfectly. Having an unimpaired view from the bi-folding doors was really important and the 6m post span is perfect. We use the space for entertaining in the summer months but as we are quite near the coast, protection from the wind was important. The sliding doors work so well and maintain the uninterrupted view of the garden and coastline."*

**MR & MRS SIMPSON  
BOURNEMOUTH, DORSET**







# The *Lifestyle* Glass Room

Is your customer looking for a structure that blends modern styling with minimal chic?

Why not introduce them to the Lifestyle Glass Room?

A beautiful outdoor living solution that will enhance the pleasure gained from enjoying time outdoors which is no longer limited to the warm summer months thanks to the Lifestyle Glass Room. By adding sliding glass doors and fixed glazed panels, the end user can take in the view throughout the whole year.

*"Our old veranda had vertical awnings on the sides and whilst this was great for shade protection, it wasn't good in the wind. We wanted a solution where we could have the best of both worlds and now have this with our glass room. We like the sleek design of the system and the large span between the posts. A great addition to our home."*

**MR C. SOUTHALL**  
**ELY, CAMBRIDGESHIRE**





# The *Traditional* Glass Room

## Are you looking to offer the all in one outdoor living solution?

The Traditional Glass Room is the best of the best. We have taken the elegant design of the traditional Alfresco and made it possible for use in all weather conditions, and we still managed to retain the classy yet traditional look.

This ornate high end option has been designed with elegance in mind. With a large span and projection, it truly allows the end user to take in all aspects of their garden. The fully enclosed feature allows use of the system all year round.

The sleek glass sliding doors and fixed glass panels allows your customers to adapt the purpose of their glass room all year round. They can fully open them on hot summer days, and close them during the colder months of the year to protect them from harsh winds and downpours enabling them to get the most from their outdoor living experience.

*"The patio was due for renewal and we wanted to maximise the time we spent in the garden. The traditional alfresco design fitted in with the rustic charm of our cottage and we love to entertain and relax in this space, sheltered from the elements."*

**MR G. LARSON  
MERSEYSIDE**

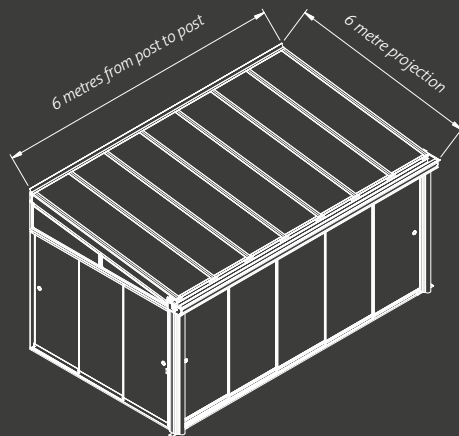



# The *Simplicity* Glass Room

Enable your customers to enhance their outdoor experience whether they like entertaining, dining or just relaxing in their garden. The versatility of a Simplicity 6 Glass Room will provide that life style.

Our stylish glass veranda now has the added feature of incorporating retractable glass sliding doors and fixed panels to create an outdoor room that is weather protected and can be used all year round.

The Simplicity 6 Glass Room is the perfect choice for domestic gardens due to its shading and optional heating and lighting features. This system will transform the UK glass room market as it has all the style, features and benefits of all glass room systems but the **PRICE and QUALITY** will exceed all expectations.

The framework is completely manufactured from aluminium and can be powder coated to a RAL colour. It also features 6mm toughened glass that is available in a range of tinted options.

*"Due to the limited patio space we had, it was a struggle to find a product which didn't take up a lot of space but would give us a sheltered area that we could enjoy the garden in all year round. The Simplicity 6 Glass Room met our needs perfectly and we find ourselves in it most days thanks to the heaters and lighting that we opted for."*

**MRS G. BRAITHWAITE**  
**ESHER, SURREY**

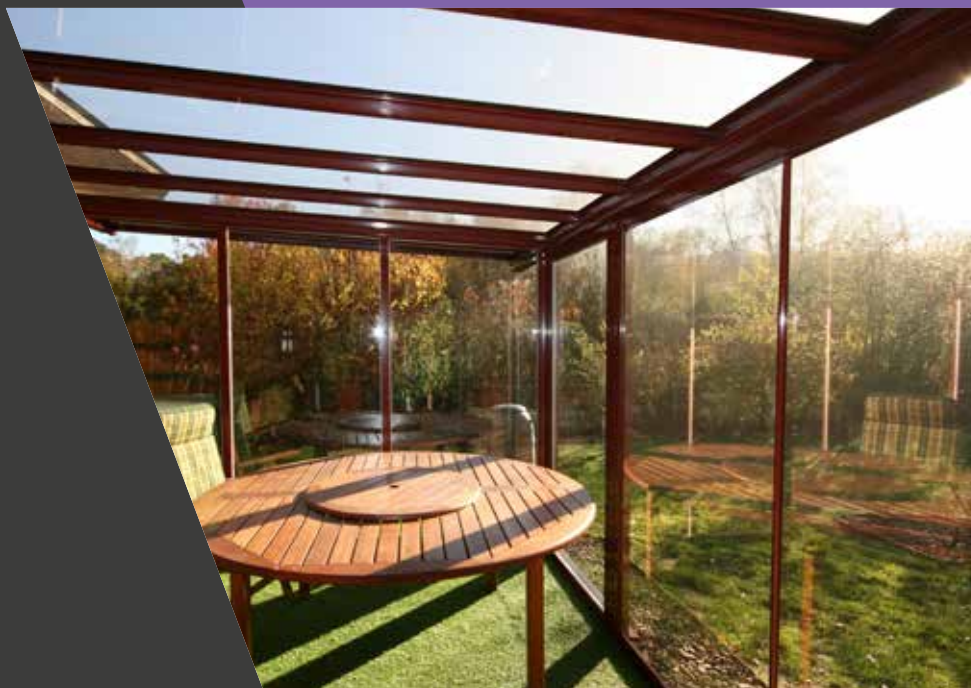
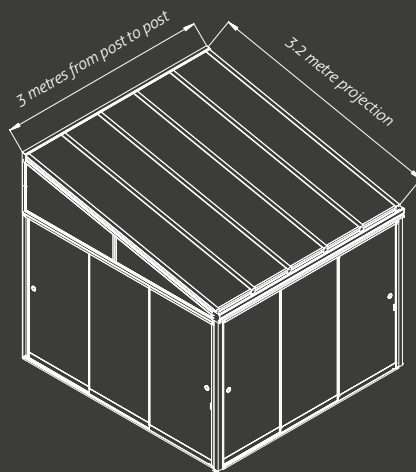



# The *Bioclimatic* Glass Room

The Bioclimatic Glass Room is the ultimate in modern design, this truly individual solution can be configured to meet any design requirements.

It is available with fixed glass panels, sliding glass doors, vertical zip screens, LED lighting and adjustable louvered vertical panels. You can be assured that there is a solution that will meet your customers requirements.

With this system the end user really has the best of both worlds, they can simply open the doors or adjust the louvers in the roof for ultimate control over their outdoor experience.



*"We love the "wow" factor of our pergola and the versatility that it brings. Adding the glass doors create the ultimate garden room which is a comfortable space all year round. It's the envy of the neighbourhood!"*

**MR & MRS TOWNSHEND  
ST. ALBANS, HERTS**

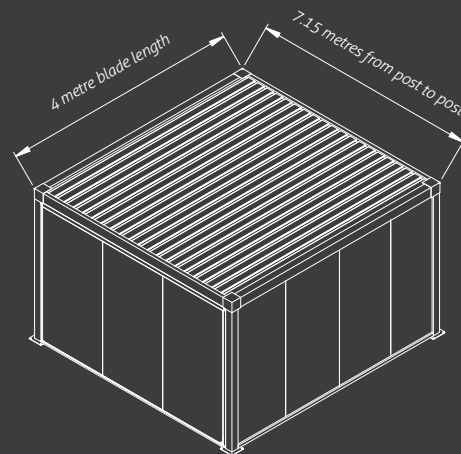



# The *Alfresco* Range

**The all new Alfresco Range consists of 3 very different looking structures to compliment any surrounding. Whether it's traditional, contemporary or something a little more subtle, the Alfresco Range really does have it covered. All structures are available with integrated LED lighting, heating, the glass room upgrade and hidden fixings.**

All systems within the Alfresco range have the option to span a massive 6 metres from post to post which means that the view is never compromised.

We have worked closely with a leading designer to create an innovative and truly stunning range of systems that will enhance and add value to your customer's homes, allowing them to be sheltered and comfortable in their gardens whatever the weather.

The structures can be glazed with either 8mm toughened glass or 35mm polycarbonate sheets. The glass option

offers improved acoustic properties reducing the noise of rain during a downpour as well as providing a sparkling finish which is easy to maintain.

Like our other systems they are made completely from aluminium for ultimate longevity. They feature easy-fix clip on profiles that hide fixings and downpipes to give a stylish and modern look. This also means that any cabling for additional extras such as lighting, heating or even a sound system can be hidden from view with no unsightly trailing cables.

Each system can be manufactured to an exact size to suit requirements and can be polyester powder coated to ANY RAL or BS colour.

The Alfresco is supplied with a 10 year guarantee and a minimum 25 year life expectancy and many optional extras. The 3 systems shown overleaf are the Contemporary Alfresco with its clean minimal looks, the Lifestyle Alfresco with its rounded face soft finish and the Traditional Alfresco with its ornate gutters, clip-on claddings and stunning high end finish.



# 3 options

**Ideal for BIG SPAN VERANDAS, GLASS ROOMS  
and OUTDOOR DINING CANOPIES.**

The Alfresco Range is the latest addition to our veranda range and with its massive 6 metre span between posts, your customers view is never compromised.

It is available with LED integrated lighting, heating has concealed fixings and is made entirely from aluminium. The Alfresco Range is the perfect solution for creating a unique and practical outdoor space for garden parties, barbecues and all kinds of family and social events all year round.

**All of the Alfresco structure are available  
with a 35mm polycarbonate roof system**



**The *Contemporary*  
Alfresco**



**The *Lifestyle*  
Alfresco**



**The *Traditional*  
Alfresco**



option **1**



# The *Contemporary* Alfresco

Introducing the Contemporary Alfresco, with clean lines and minimal looking aluminium extrusions which have been designed with simplicity in mind. This sleek, yet modern structure has a subtle elegance that will never go out of style.



The optional integrated LED Lighting and heaters enable your customers to use the structure in to the evening, and for complete shelter from the elements they can opt for the glass room upgrade as seen on pages 6-7.

The fixings are hidden with aluminium trims and the downpipes are inside of the posts and can be connected either underground drainage or diverted to a surface drain.

**Cross section view**

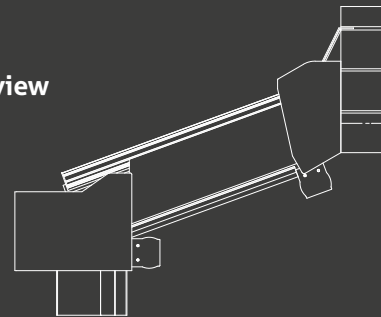

SUITABLE FOR BIG SPAN CARPORTS



SUITABLE FOR BIG SPAN VERANDAS & OUTDOOR DINING CANOPIES

*Canopy above includes a Screener Veranda Upgrade see pages 72-73*

option 1

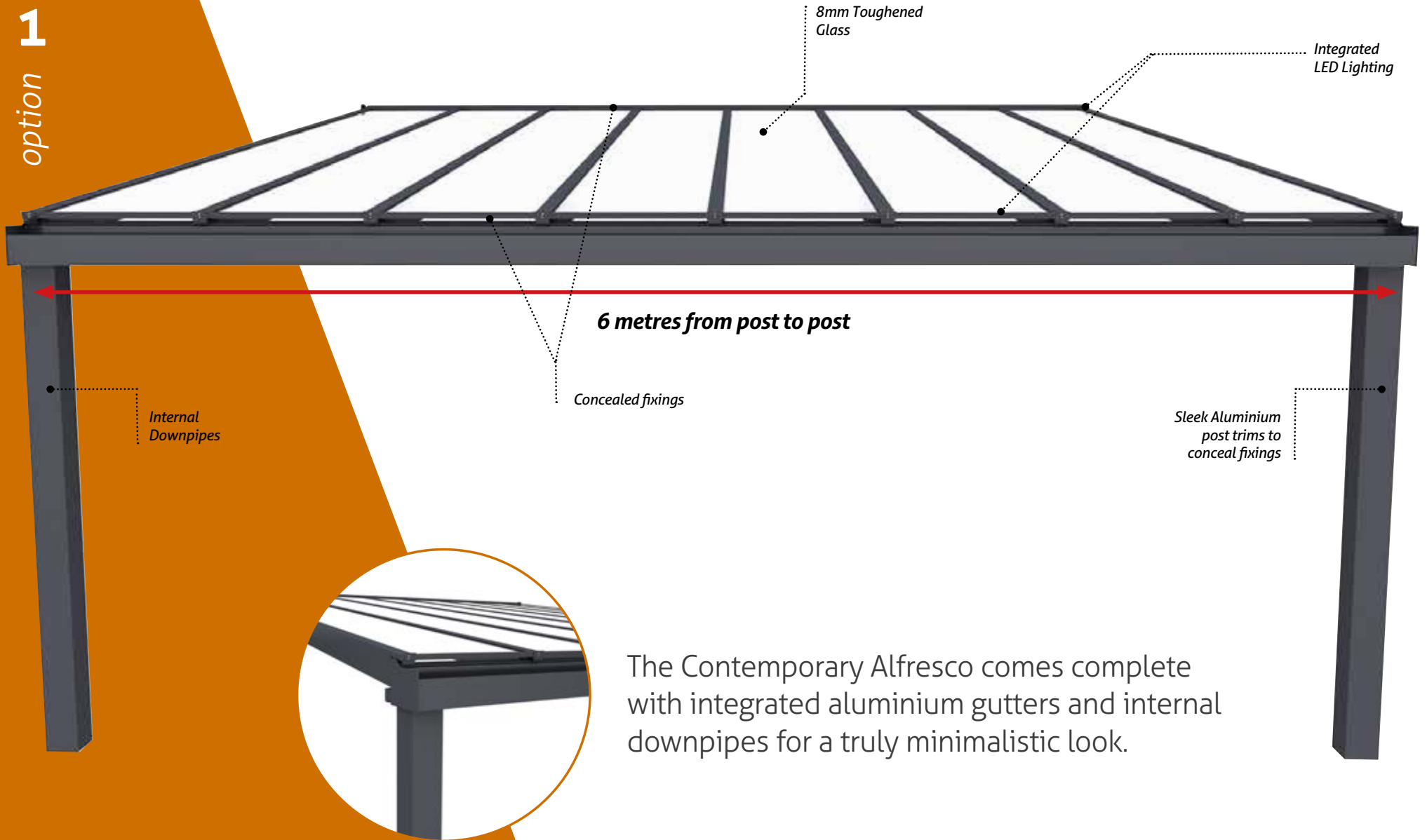

The Contemporary Alfresco comes complete with integrated aluminium gutters and internal downpipes for a truly minimalistic look.

# The *Contemporary* Alfresco

## Features & Benefits

- **Full 10 Year Guarantee** – The Alfresco Range is supplied with a full 10 year guarantee and a minimum 25 year life expectancy for the canopy frame
- **Choice of Glass or Polycarbonate** – Choose to have either 8mm toughened glass or 35mm polycarbonate which is Class 1 BS EN 12600 for impact Performance
- **Low Maintenance** – All systems are aluminium so maintenance is significantly reduced compared to PVC options which are available elsewhere on the market
- **Available Projections** – Up to an impressive 6 metres maximum
- **Integral Aluminium Guttering and Easy-Fix Profiles** – Creates a sleek, modern design

### Projection up to 6m

#### Posts Spacing

**Projection:** Up to 6m

**Spacing:** 6.0m

#### Glazing Bars Spacing

**Projection:** Up to 6m

**Spacing:** 800mm

#### Pitch

5 degrees minimum to 45 degrees maximum

*These are general calculations, once we understand your requirements we will perform an assessment for wind and snow loadings based on your postcode.*

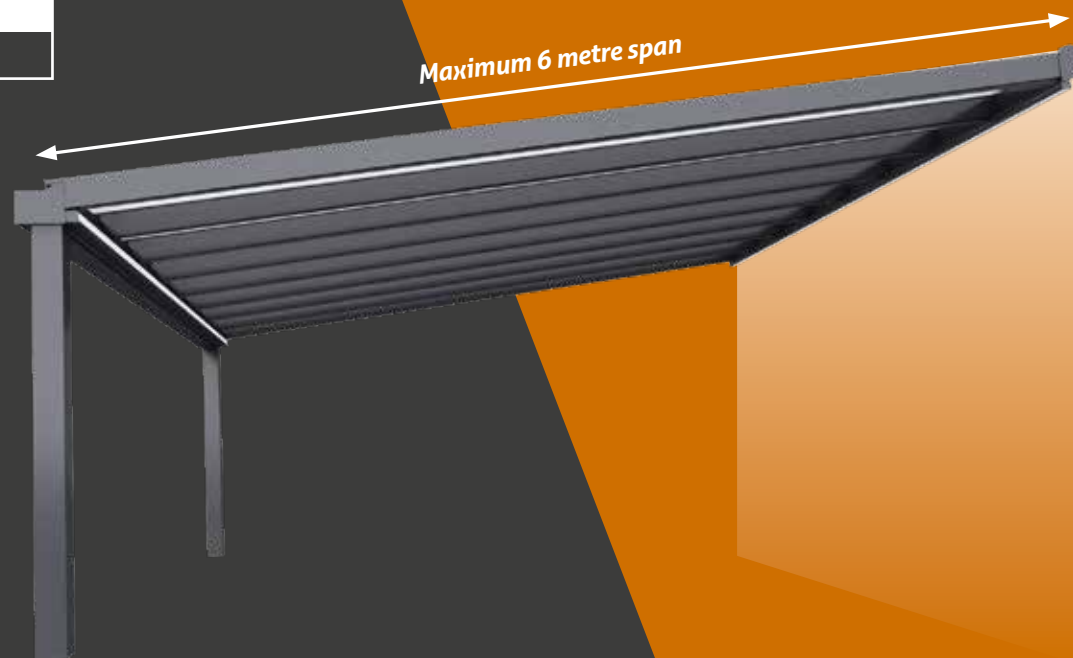

*The Contemporary Alfresco has an Integrated LED Lighting System and aluminium trims to conceal the fixings and give a quality finish.*



# The *Contemporary* Alfresco

## Optional Upgrades

The Contemporary Alfresco can be supplied with a host of upgrades to enhance the experience of using the area.

*These include:*

- **Remote Controlled Integrated LED Lighting** which will enable your customers to enjoy the area into the evening.
- **Infrared Heaters** to make the area more comfortable on those chilly days and nights.
- **Fixed or Sliding Glass Side or Front Panels** to give your customers complete weather protection around the front or the sides of the structure.
- For the best of both worlds a **Screener Veranda** can be installed on top of the structure to offer automated shade whenever required
- **Wide Range of Colour Options** – The aluminium frame can be finished to any BS or RAL colour



**GLASS ROOM**



**LED LIGHTING AVAILABLE**



**INFRARED HEATERS AVAILABLE**



**SCREENER VERANDA SUN SCREEN**



**ANY RAL COLOUR OPTION**

Available as a Glass Room Upgrade. See pages 6-7 for more details.



Available in any RAL colour



Glass Room Upgrade



Screener Veranda Upgrade

option 2

# The *Lifestyle* Alfresco

Introducing the Lifestyle Alfresco, this fresh rounded option has also been designed with simplicity in mind. This sleek structure is subtle and complements any surrounding.

The optional integrated LED lighting and heaters enable your customers to use the structure during in the evening and for complete shelter from the elements they can opt for the glass room upgrade as seen on page 8-9.

The fixings are hidden with aluminium trims and the downpipes are hidden inside of the posts and can be connected either underground or diverted to a surface drain.



Cross section view

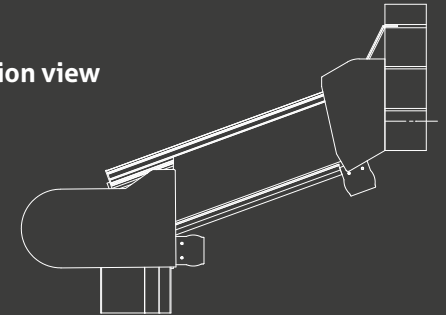

SUITABLE FOR BIG SPAN CARPORTS



SUITABLE FOR BIG SPAN VERANDAS & OUTDOOR DINING CANOPIES





option 2

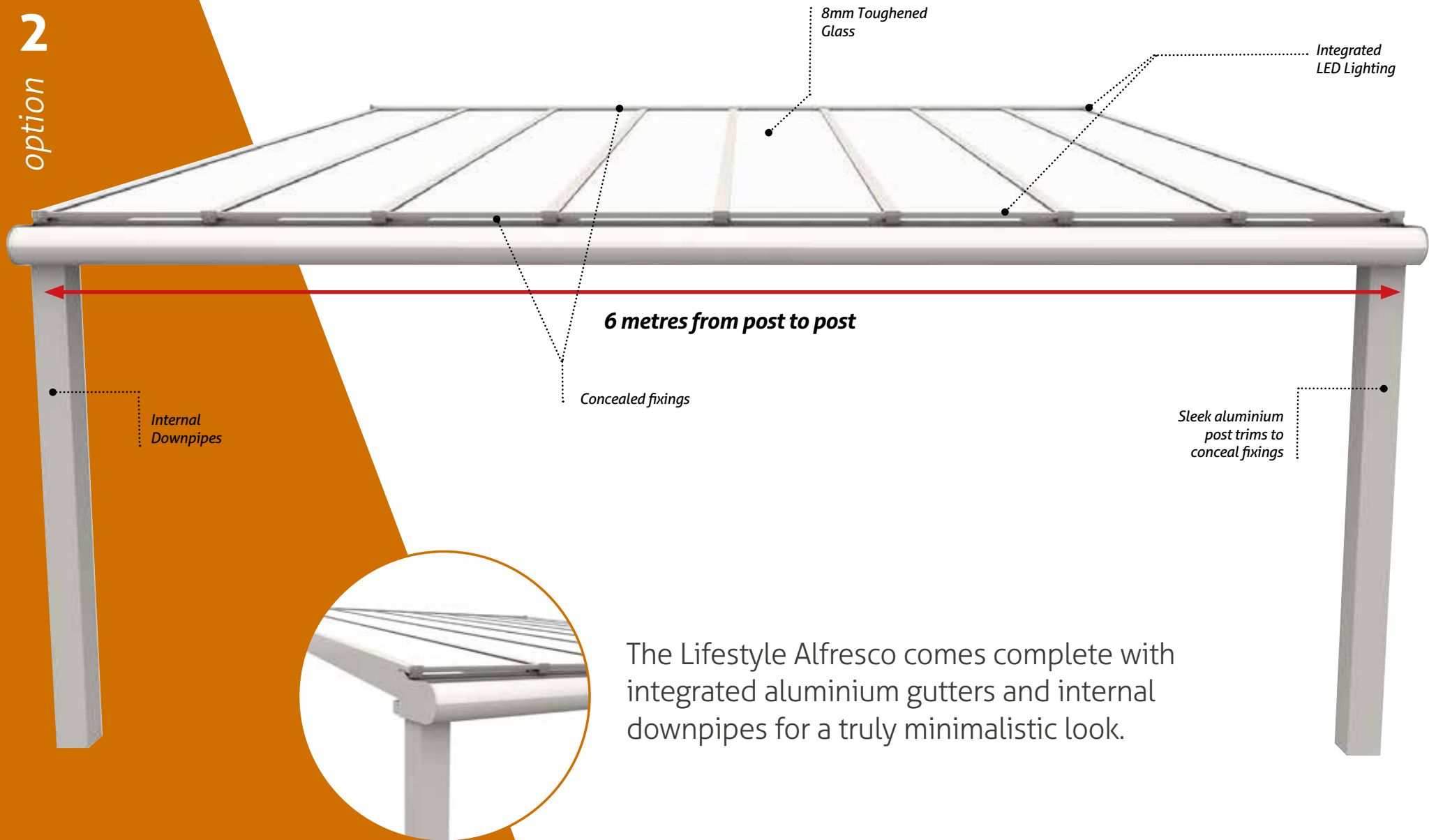

The Lifestyle Alfresco comes complete with integrated aluminium gutters and internal downpipes for a truly minimalistic look.

# The *Lifestyle* Alfresco

## Features & Benefits

- **Full 10 Year Guarantee** – The Alfresco Range is supplied with a full 10 year guarantee and a minimum 25 year life expectancy for the canopy frame
- **Choice of Glass or Polycarbonate** – Choose from either 8mm toughened glass or 35mm polycarbonate which is Class 1 BS EN 12600 for impact performance
- **Low Maintenance** – All systems are aluminium so maintenance is significantly reduced compared to PVC options which are available elsewhere on the market
- **Available Projections** – Any minimum and a massive 6 metres maximum
- **Integral Aluminium Guttering and Easy-Fix profiles** – Creates a sleek, modern design

### Projection up to 6m

#### Posts Spacing

**Projection:** Up to 6m

**Spacing:** 6.0m

#### Glazing Bars Spacing

**Projection:** Up to 6m

**Spacing:** 800mm

#### Pitch

5 degrees minimum to 45 degrees maximum

*These are general calculations, once we understand your requirements we will perform an assessment for wind and snow loadings based on your postcode.*

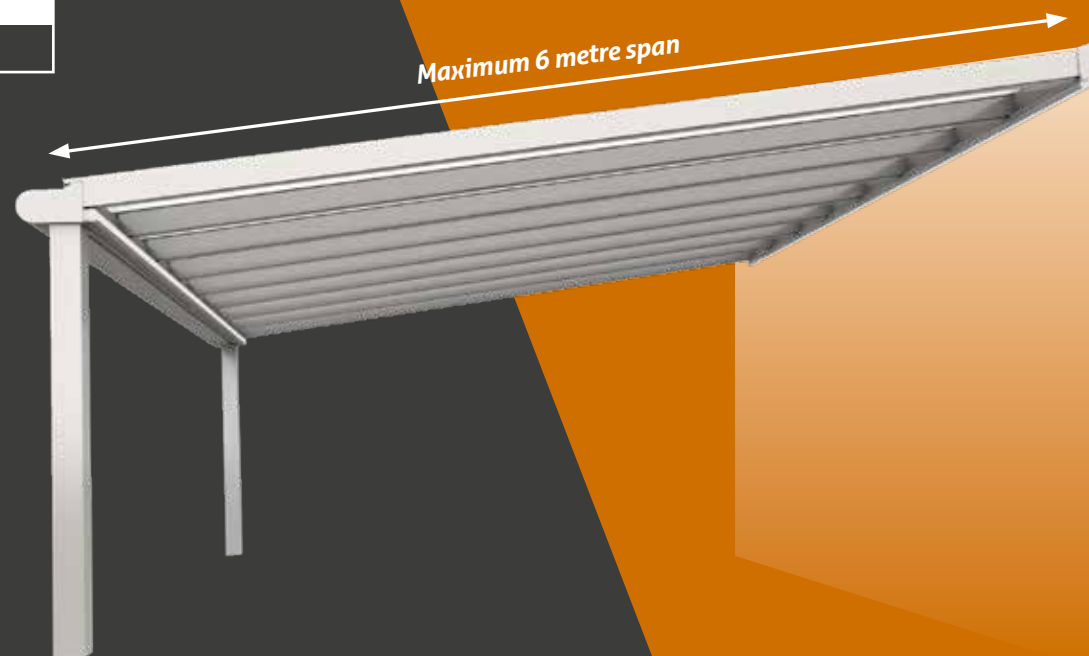

*"We were really impressed with the final design and detail of the structure and take our hats off to the installation team!"*

MR & MRS WOOD - MAIDSTONE, KENT

option **2**



# The *Lifestyle* Alfresco

## Optional Upgrades

The Lifestyle Alfresco can be supplied with a host of upgrades to enhance the experience of using the area.

*These include:*

- **Remote Controlled Integrated LED Lighting** which will enable your customers to enjoy the area into the evening.
- **Infrared Heaters** to make the area more comfortable on those chilly days and nights.
- **Fixed or Sliding Glass Side or Front Panels** to offer complete weather protection around the front or the sides.
- For the best of both worlds the **Screener Veranda** can be installed on top of the structure to give automated shade whenever you feel the need for shade.
- **Wide Range of Colour Options** – The aluminium frame can be finished to any BS or RAL colour



**GLASS ROOM**



**LED LIGHTING AVAILABLE**



**INFRARED HEATERS AVAILABLE**



**SCREENER VERANDA SUN SCREEN**



**ANY RAL COLOUR OPTION**

Available as a Glass Room Upgrade. See pages 8-9 for more details.



Available in any RAL colour



**Glass Room Upgrade**



**Screener Veranda Upgrade**

# The *Traditional* Alfresco

Introducing the Traditional Alfresco. This ornate, high-end option has been designed with elegance in mind. This traditional looking structure complements the most sophisticated of buildings.

The optional integrated LED Lighting and heaters enable your customers to use the structure in the evening and for complete shelter from the elements they can opt for the glass room upgrade as seen on page 10-11.

The fixings are hidden with aluminium trims and the downpipes are hidden inside of the posts and can be connected either underground or diverted to a surface drain.



Cross section view



SUITABLE FOR BIG SPAN CARPORTS



SUITABLE FOR BIG SPAN VERANDAS & OUTDOOR DINING CANOPIES



option 3



The Traditional Alfresco comes complete with integrated aluminium gutters and internal downpipes for a truly minimalistic look.



# The *Traditional* Alfresco

## Features & Benefits

- **Full 10 Year Guarantee** – The Alfresco Range is supplied with a full 10 year guarantee and a minimum 25 year life expectancy for the canopy frame
- **Choice of Glass or Polycarbonate** – Choose from either 8mm toughened glass or 35mm polycarbonate which is Class 1 BS EN 12600 for impact Performance
- **Low Maintenance** – All systems are aluminium so maintenance is significantly reduced over other PVC options available elsewhere on the market
- **Available Projections** – Up to an impressive 6 metres
- **Integral Aluminium Guttering and Easy-Fix profiles** – Creates a sleek, modern design.

### Projection up to 6m

#### Posts Spacing

**Projection:** Up to 6m

**Spacing:** 6.0m

#### Glazing Bars Spacing

**Projection:** Up to 6m

**Spacing:** 800mm

#### Pitch

5 degrees minimum to 45 degrees maximum

*These are general calculations, once we understand your requirements we will perform an assessment for wind and snow loadings based on your postcode.*

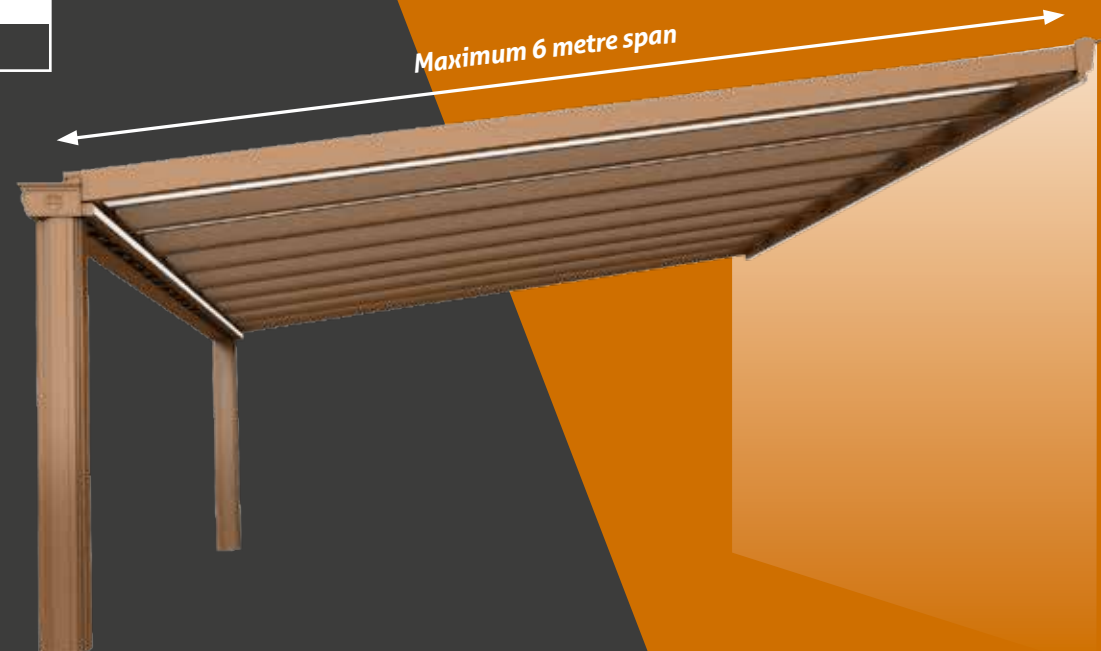

*"Thank you for a really nice job, it looks great."*

MR. MARTIN - ROMFORD, ESSEX

option **3**

*The Traditional Alfresco has an Integrated LED Lighting System and aluminium trims to conceal the fixings and give a quality finish.*



# The *Traditional* Alfresco

## Optional Upgrades

The Traditional Alfresco can be supplied with a host of upgrades to enhance the experience of using the area.

*These include:*

- **Remote Controlled Integrated LED Lighting** which will enable the area to be enjoyed in the evening.
- **Infrared Heaters** to make the area more comfortable on those chilly days and nights.
- **Fixed or Sliding Glass Side or Front Panels** to offer complete weather protection around the front or the sides.
- For the best of both worlds the **Screener Veranda** can be installed on top of the structure to give the customer automated shade whenever they feel the need for shade.
- **Wide Range of Colour Options** – The aluminium frame can be finished to any BS or RAL colour



**GLASS ROOM**



**LED LIGHTING AVAILABLE**



**INFRARED HEATERS AVAILABLE**



**SCREENER VERANDA SUN SCREEN**



**ANY RAL COLOUR OPTION**

Available as a Glass Room Upgrade. See pages 10-11 for more details.



Available in any RAL colour



Glass Room Upgrade



Screener Veranda Upgrade

# The *Simplicity* Range

**The Simplicity range of solutions have been designed with quality longevity and speed of installation in mind.**

We have developed these systems to be completely made from aluminium so that they last the rigorous of the British weather.

They can be glazed with either glass or polycarbonate so that you can be assured they can meet most budgets.

We place a lot of importance on keeping things simple and quick to install (hence the name) this means these products are really simple for your clients to maintain.

Having a range of options is also important so that customers can enhance the experience by adding upgrades like lighting, heating and additional protection from the elements.



Cost effective carport or garden veranda systems that are quick and easy to install.

# 3 options

## All aluminium solutions available in any colour

We have 3 very different options with 3 sets of upgrades within the Simplicity range which will enable you to specify a product to most applications and budgets.

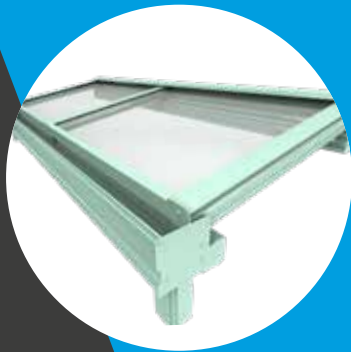

The *Simplicity 6*

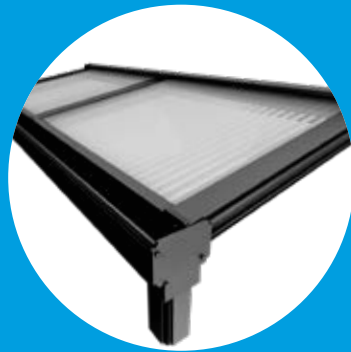

The *Simplicity 16*

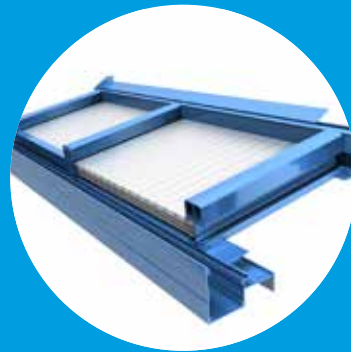

The *Simplicity 35*



option **H**



# The *Simplicity 6*

The Simplicity 6 is a stylish veranda, canopy and carport system that is glazed with a choice of 6mm toughened glass.

With elegant posts and optional glass roofing, this product offers you a deluxe canopy or veranda at an affordable price. By featuring the option of glass roofing, the Simplicity 6 offers improved acoustic properties – reducing the noise of rain drops during a downpour; these glass panels also provide a sparkling finish which is easy to maintain, particularly if the self-cleaning glass is chosen.

All framework is constructed from durable aluminium, with the option to powder coat the structure to any RAL colour or BS colour.

The Simplicity 6 is the perfect veranda solution for domestic gardens and provides effective and stylish cover from the weather for alfresco dining and garden parties.

With a span of up to 3.2m glass length from its supporting wall, and an unlimited length you will have a solution that can be adapted to suit your exact needs.

The Simplicity 6 comes with a full 10 year guarantee and a 25 year life expectancy, making this a real investment that you will be able to enjoy for many years to come.

**Now available in either white or anthracite grey as standard.**

*"The veranda has made a big difference to our property and it has created a great outside space all year around. In warm weather it's great for eating outside and to entertain and in cooler or wetter weather can still be used to sit outside in the garden with some shelter."*

**MR. GREEN - BASILDON, ESSEX**



SUITABLE FOR GARDEN  
VERANDAS & CANOPIES



SUITABLE FOR  
DINING AREAS



*Victorian post upgrade*

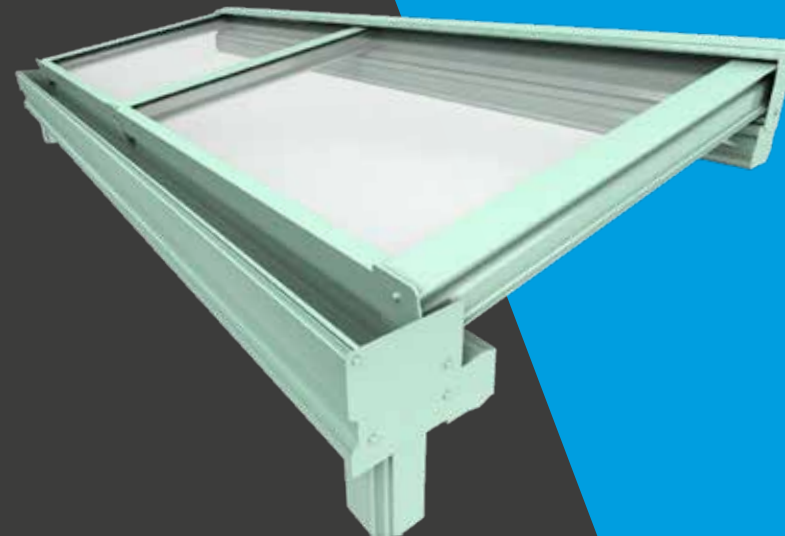

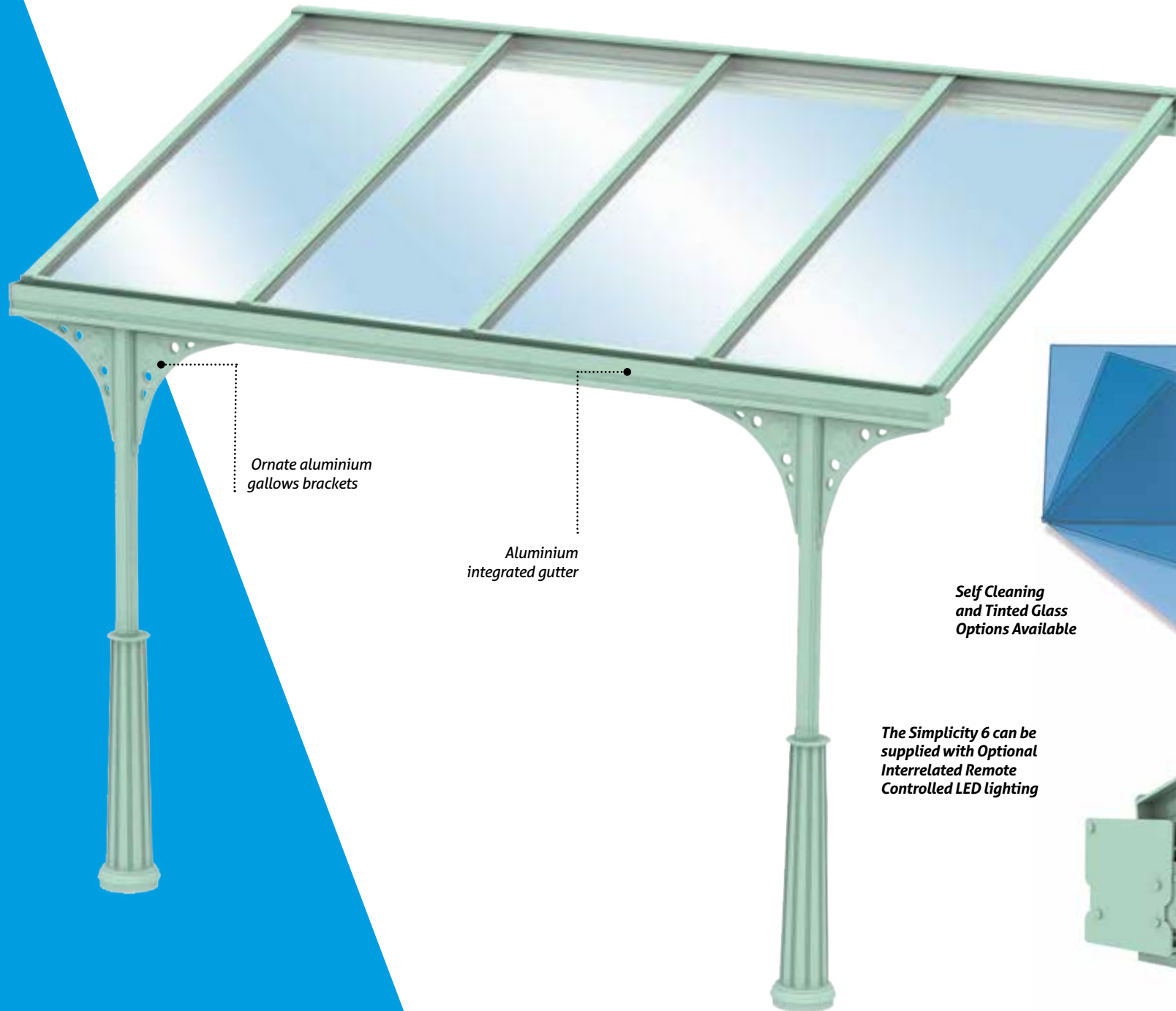

*Ornate aluminium  
gallows brackets*

*Aluminium  
integrated gutter*



*Self Cleaning  
and Tinted Glass  
Options Available*

*The Simplicity 6 can be  
supplied with Optional  
Interrelated Remote  
Controlled LED lighting*





# The *Simplicity 6*

## Features & Benefits

- **Full 10 Year Guarantee** – The Simplicity 6 is supplied with a full 10 year guarantee and a 25 year life expectancy for the canopy frame
- **UV Activated Self-Cleaning Glass** – Optional 6mm self-cleaning toughened glass has a UV activated special coating that is applied during manufacture that breaks down organic dirt which is then washed away by the rain. Only a small amount of UV is needed to activate the special coating so that the veranda remains clean even on cloudy days
- **Toughened Glass** – Both glass options are toughened during manufacturing and achieve Class 1 BS EN 12600 for impact performance
- **Low Maintenance** – All roof options are low maintenance, particularly the self-cleaning glass, which means less cleaning is required, saving you time and money
- **High Light Transmittance** – All roof options offer high light transmittance
- **Available Projections** – Up to 3.2m projection (Bar length)

- **Simple Fixing System with Minimal Parts** – For a simple and speedy installation
- **Low Profile** – The Simplicity 6 can be fitted in height restricted areas
- **Integral Aluminium Guttering** – Creates a sleek, modern design which is stronger than external guttering systems and saves time on installation

**Information on the design load and maximum span limits is available on request.**

Projection up to 3.2m

Posts Spacing
<b>Projection:</b> Up to 3.2m
<b>Spacing:</b> 3.0m
Glazing Bars Spacing
<b>Projection:</b> Up to 3.2m
<b>Spacing:</b> 600mm
Pitch
From 2.5 degrees to 22.5 degrees

*These are general calculations, once we understand your requirements we will perform an assessment for wind and snow loadings based on your postcode.*



**Optional Galls Included**



**Optional Base Castings and Galls Included**

option **H**



# The *Simplicity* 6

## Optional Upgrades

- **Wide Range of Colour Options** – The aluminium frame can be finished to any BS or RAL colour
- **Victorian Upgrade Available** – Enhance your structure with traditional style decorative post sleeves and gallows brackets
- **Infrared Heaters** - Wall Mounted Infrared Heaters can be added to the veranda to create a warm and cosy atmosphere
- **Integrated LED Lighting Available** – Lighting can be added to the veranda to enable your customers to entertain when the sun goes down
- **Glass Options** – 6mm clear toughened, 6mm clear self-cleaning, 6mm toughened tinted grey and blue and 6mm toughened self-cleaning tinted blue glass.

-  **VICTORIAN UPGRADE**
-  **OPTIONAL REMOTE CONTROLLED LED LIGHTING AVAILABLE**
-  **INFRARED HEATERS AVAILABLE**
-  **GLASS OPTIONS**
-  **ANY RAL COLOUR OPTION**
-  **CONTEMPORARY 70MM x 70MM SQUARE POST AVAILABLE**



LED Remote Control Unit

Available in any RAL colour



Victorian Upgrade



Optional Integrated Lighting



Infrared Heaters

option 2



*Image above shows additional side panels supplied by a trade partner.*

# The *Simplicity* 16

It's simple; the Simplicity 16 has been developed with speed of installation, durability and cost in mind.

Due to its clever design, the Simplicity 16 provides a durable and attractive shade and shelter solution at our most cost-effective price. It can project up to 4 metres (subject to technical loading calculations) and has a lightweight roofing system, making it perfect for use as a carport or veranda.

The stylish modern design gives a look that is second to none, enhancing the adjoining building's aesthetics. It also offers unbeatable structural performance, simply outperforming all other carport and canopy systems pound for pound.

This highly versatile canopy and carport system offers a variety of solutions for:

- Carports
- Verandas
- Smoking Shelters
- Walkway Canopies
- Covered Play Areas
- Porch Canopies
- Caravan Shelters

## **The Benefits of using this system:**

**All-aluminium system:** The Simplicity 16 is manufactured solely from aluminium to offer exceptional longevity and easy maintenance. It also features hidden, integral guttering for a clean, modern appearance.

**High speed installation:** We have developed this system in partnership with one of the most prolific extrusion designers in the industry. Through his extensive expertise and using our knowledge gained from 25 years experience, we have created the simplest fixing system possible.

**Impact resistance:** Some of the systems on the market today use PVC or GRP roof panels which do not have the impact resistance of polycarbonate. We only use triple wall 16mm polycarbonate sheeting to ensure that the structure lasts and has the impact resistance and the snow loading capabilities suitable for anywhere in the UK.

**Variable Roof Pitch:** Unlike the majority of roof kits, which only offer a fixed pitch, the Simplicity 16 offers a pitch range of 2.5 degrees to 22.5 degrees to give more height at the back or to enable a low wall plate installation.

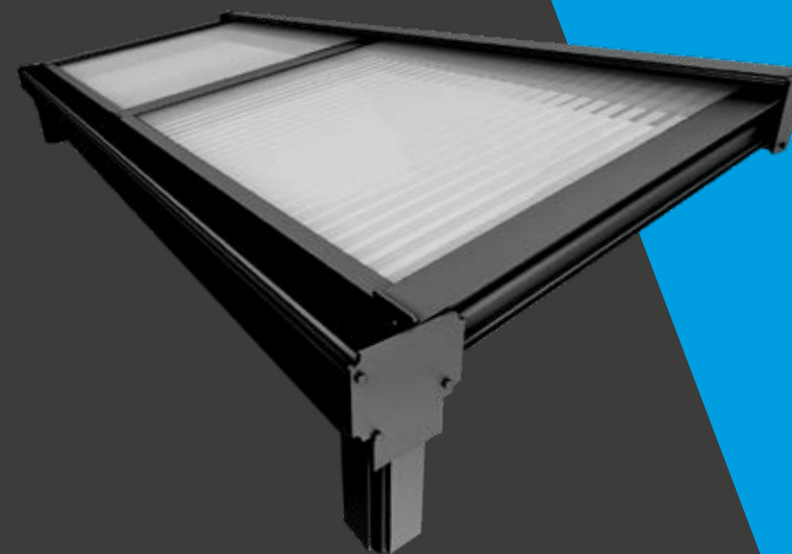

SUITABLE FOR  
GARDEN CANOPIES



SUITABLE FOR  
CARPORTS

option 2

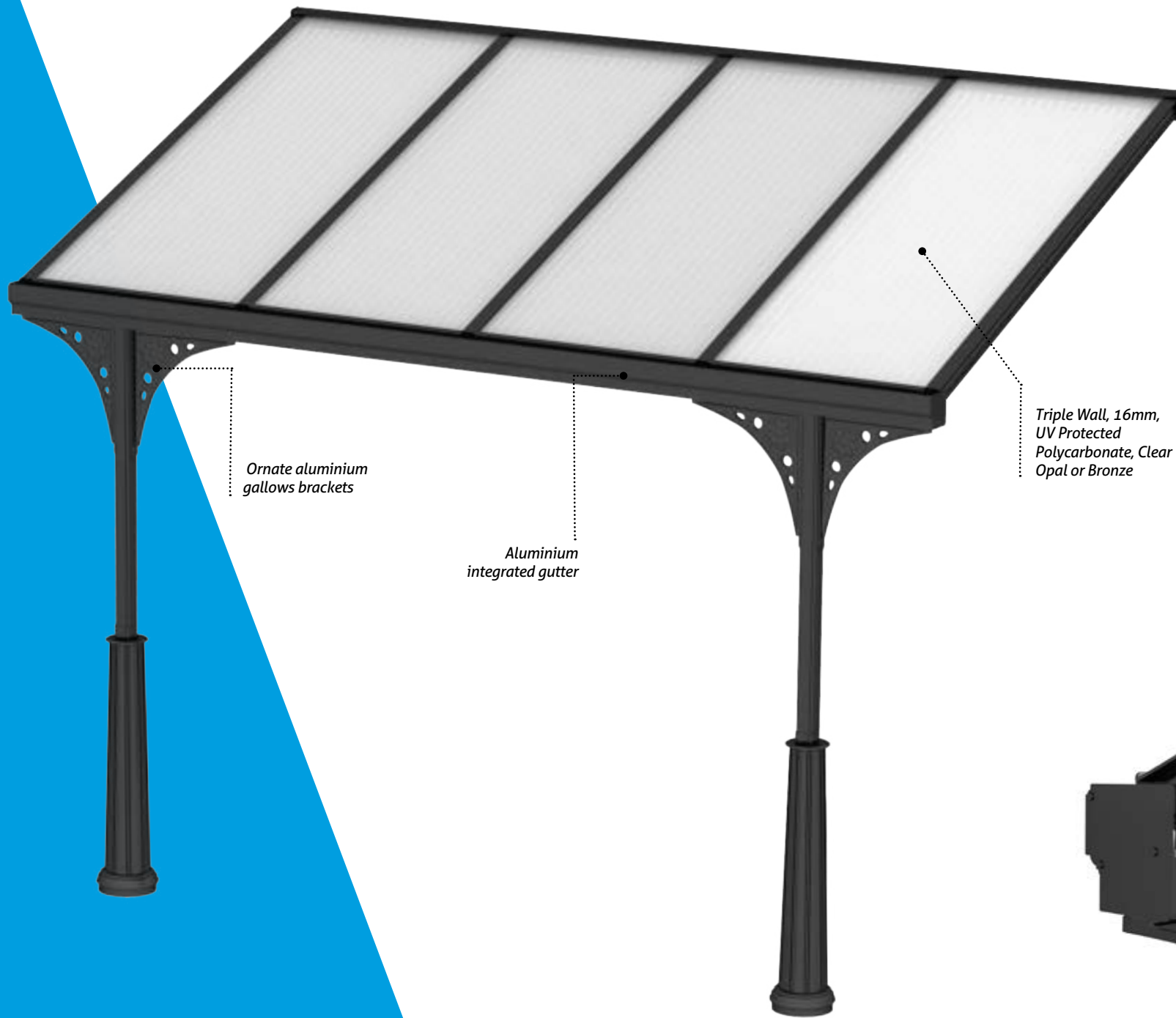

*Ornate aluminium  
gallows brackets*

*Aluminium  
integrated gutter*

*Triple Wall, 16mm,  
UV Protected  
Polycarbonate, Clear  
Opal or Bronze*

# The *Simplicity* 16

## Features & Benefits

- **Available in any length**
- **Available Projections** – Available up to 4m projection depending on snow load
- **Full 10 Year Guarantee** and a 25 year Life Expectancy
- **Simple fixing system with minimal parts** - For quick and easy installation
- **Low profile** – The Simplicity 16 can be fitted in areas where height is restricted
- **Stainless Steel Fixings** – All fixings are 316 marine grade stainless steel
- **Integral Aluminium Guttering** – Saves time on installation and is also stronger than an external gutter system.
- **16mm Structured Polycarbonate Panels** – Available in a clear or opal finish
- **High UV Protection** – A layer of UV absorber is co-extruded onto our roofing panels to offer high UV protection

Information on the design load and maximum span limits are available on request.

### Projection up to 4m

Posts Spacing			
Projection:	Up to 4m		
Spacing:	3.0m		
Glazing Bars Spacing			
Projection:	Up to 3m	3.001m - 3.5m	4m
Spacing:	1m	700mm	500mm
Pitch			
From 2.5 degrees to 22.5 degrees			

*These are general calculations, once we understand your requirements we will perform an assessment for wind and snow loadings based on your postcode.*

*"We are extremely pleased with this and have had nothing but excellent responses from everyone who has seen it."*

MR. PEEL  
BLANDFORD FORUM, DORSET



Optional Gallows Included



Optional Base Castings and Gallows Included

option 2

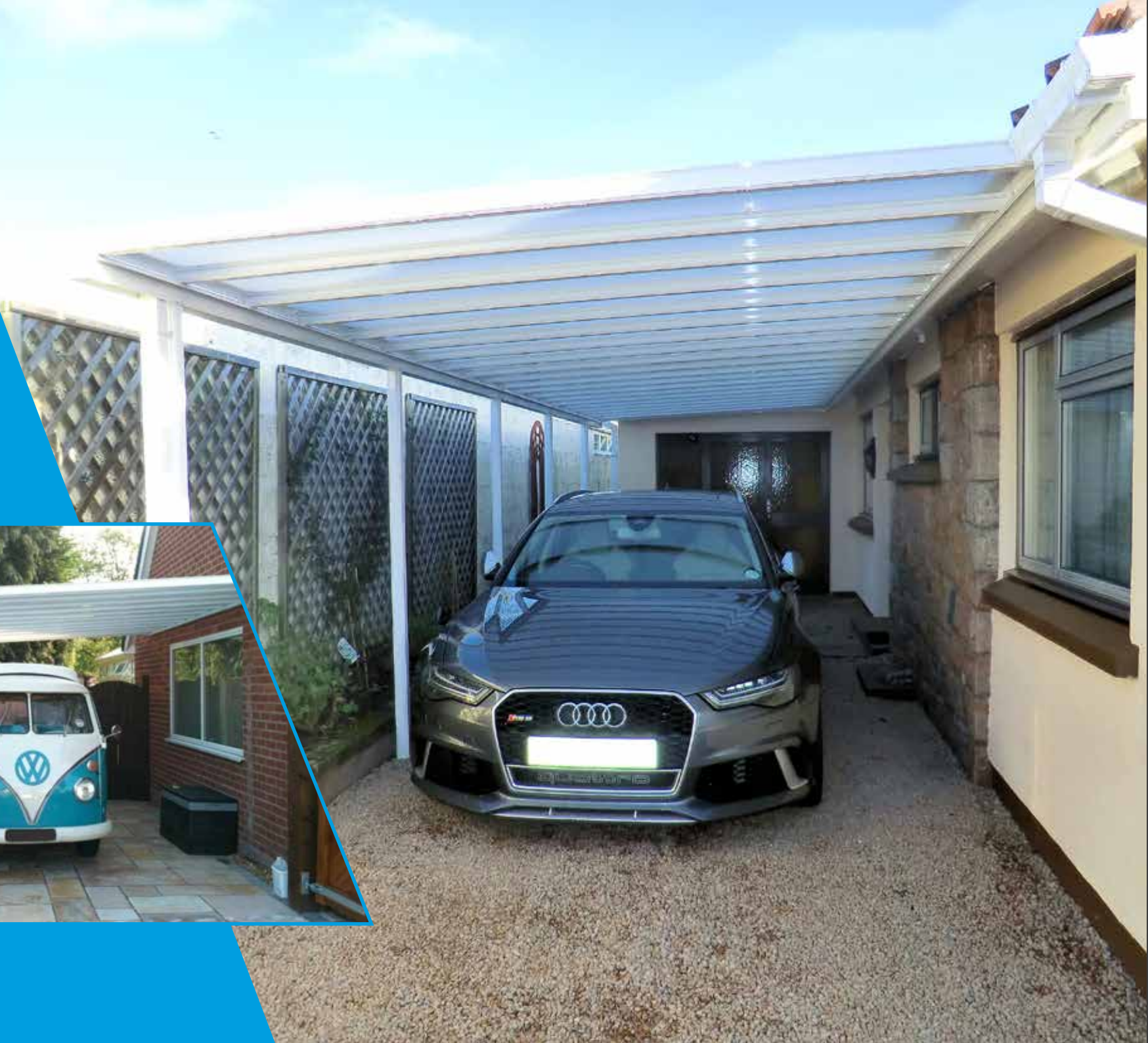







# The *Simplicity* 16

## Optional Upgrades

The Simplicity 16 can be supplied with upgrades as follows:

- **Wide Range of Colour Options** – The framework can be finished to any RAL or BS colour
- **Victorian Upgrade Available** – Enhance the structure with traditional style decorative post sleeves and gallows brackets
- **Integrated LED Lighting Available** – Lighting can be added to your veranda to enable your customers to entertain when the sun goes down
- **Infrared Heaters Available** – Infrared Heaters can be added to the to your veranda to create a warm and cosy area underneath
- **Roof Panel Colours** can be either Opal, Clear or Bronze

-  **VICTORIAN UPGRADE**
-  **OPTIONAL LED LIGHTING AVAILABLE**
-  **INFRARED HEATERS AVAILABLE**
-  **ROOF PANEL COLOUR OPTIONS**
-  **ANY RAL COLOUR OPTION**
-  **CONTEMPORARY 70MM x 70MM SQUARE POST AVAILABLE**



Victorian Upgrade



Available in any RAL colour



Infrared Heaters



# The *Simplicity* 35

A large domestic or commercial solution. Perfect for schools, colleges, hospitals and local Authority establishments or large span carports and verandas due to its durability, versatility, and unlimited length.

It is **completely constructed from aluminium**, giving you a structure with unbeatable durability together with a life expectancy of up to 25 years. This robust system is also supplied with a full 10 year guarantee.

The Simplicity 35 can be manufactured to **any length** to meet specific requirements and can **span up to 6 metres**, enabling you to cover multiple cars easily with minimum posts. It has a modern, stylish appearance and benefits from robust integral aluminium guttering which creates an attractive finish to the structure whilst also ensuring a quick installation. Furthermore, this aluminium guttering requires minimal subsequent maintenance throughout the products lifetime.

The Simplicity 35 system features 35mm structured polycarbonate roof panels, which are available in clear or opal and

offers in excess of 98% UV protection which reduces the risk of your vehicle paintwork fading and will protect anyone using the area from harmful UV rays.

The Simplicity 35 has a **variable wall pitch from 2.5° - 45°** so that you can decide on the height of the wall-plate to suit your needs – ideal for taller vehicles such as campervans and caravans. The aluminium framework, which is supplied in white as standard, can be coloured to any RAL or BS colour to match existing window and door frames or to create an attractive contrasting effect.

The Simplicity 35 is also the perfect veranda or canopy for commercial settings as well as private homes.

This contemporary yet robust system has passed the ACR(M) 001:2005 Test for Non-Fragility of Profiled Sheeted Roof

Assemblies and is certified as a Non-Fragile system (providing the installation conforms to span and loading charts – please contact us for more information). This glazing system must be used in conjunction with the supplied polycarbonate to conform to wind and snow loadings for the UK.

The Simplicity 35 is available in any RAL or BS colour to meet specific requirements.

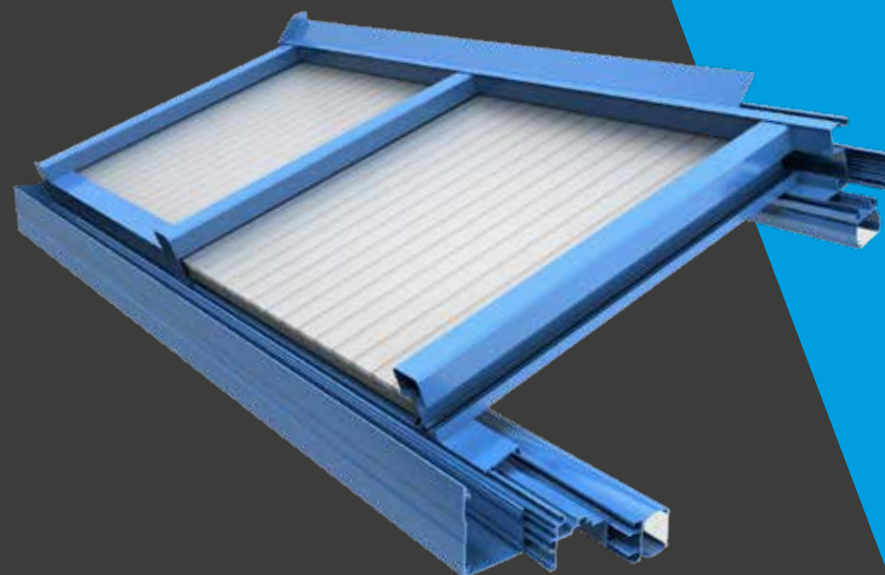

SUITABLE FOR BIG  
SPAN CARPORTS



SUITABLE FOR COMMERCIAL  
CANOPIES & WALKWAYS

option 3



*Optional Ornate  
Aluminium Gallows  
Brackets*

*Aluminium  
integrated gutter*

*Dual Gaskets on all  
Aluminium bars*

*35mm shatter resistant,  
UV protected, 7 wall  
polycarbonate sheets*

***The Simplicity 35 has an  
Integrated LED Lighting  
System and aluminium  
trims to conceal the front  
canopy fixings and give a  
quality finish.***

# The *Simplicity* 35

## Features & Benefits

- **Full 10 Year Guarantee** and a 25 year life expectancy
- **Fully Aluminium System** – Including heavy duty structural aluminium roof bars for ultimate strength
- **Stainless Steel Fixings** – All of the fixings are 316 marine grade stainless steel for longevity and total resistance to corrosion
- **Integral Aluminium Guttering** – Saves time on installation and creates a robust and attractive gutter system
- **35mm Structured Polycarbonate**  
Our 7 wall polycarbonate is amongst the strongest you can buy.
- **Fire Performance** – Polycarbonate panels benefit from excellent fire performance, meeting BS476 part 7 class 1, EN13501 and B-s1, d0
- **Robust Roof System** – The roofing system is strong enough to be walked on as a means of escape and maintenance, with the use of boards (edge protection recommended)
- **High UV Protection** – A layer of UV absorber is co-extruded on the outer surface of the roof panels which prevents damaging UV radiation from penetrating the sheet and protects those underneath from the sun. UV

protection also prevents yellowing and loss of strength to the panel, giving it longer life

- **Variable Roof Pitch** – The roof has a variable pitch of between 2.5° – 45°
- **Large Projection** – Projection of up to 6 metres to create large shaded areas if required
- **Unlimited Length** – This structure can be constructed to any length to suit requirements

**Information on the design load and maximum span limits is available on request.**

### Projection up to 6m

Posts Spacing			
<b>Projection:</b>	Up to 4m	4.1m - 6m	
<b>Spacing:</b>	3.5m	3m	
Glazing Bars Spacing			
<b>Projection:</b>	Up to 4.5m	4.5m - 5.3m	5.301 - 6m
<b>Spacing:</b>	1250mm	700mm	500mm
Pitch			
From 2.5 degrees to 45 degrees			

*These are general calculations, once we understand your requirements we will perform an assessment for wind and snow loadings based on your postcode.*



**Optional Gallows Included**



**Optional Gallows, Base Castings & Cast Collars**

option 3



# The *Simplicity* 35

## Optional Upgrades

The Simplicity 35 comes with a host of upgrades to enhance the area.

- **Wide Range of Colour Options** – The framework can be finished to any RAL or BS colour
- **Victorian Upgrade Available** – Transform the Simplicity 35 into a decorative structure with the Victorian Upgrade
- **Infrared Heaters Available** – Add Infrared Heaters to your veranda to create a warm and cosy area underneath when socialising or dining outside in your garden
- **Integrated LED Lighting Available** – Optional lighting to your veranda to enable you to entertain when the sun goes down



**VICTORIAN UPGRADE**



**OPTIONAL INTEGRATED REMOTE CONTROLLED LED LIGHTING AVAILABLE**



**INFRARED HEATERS AVAILABLE**



**ANY RAL COLOUR OPTION**



Victorian Upgrade



Optional Remote Controlled LED Lighting



Infrared Heaters



Available in any RAL colour



LED Remote Control Unit

# Infrared Outdoor *Heaters*

**The infrared wall mounted heaters have ceramic elements that are designed to gently warm adults and children whilst outdoors under a covered structure such as a canopy using Far Infrared technology which is completely harmless and contains no ultraviolet radiation or fumes.**

The heaters also do not emit or noise and provide a gentle heat similar to the feeling of the winter sun.

Your customers can enjoy keeping warm outside without feeling too hot and without experiencing any unsightly glare.

The ceramic plates generate heat quickly and reach their full operating temperature within less than 10 minutes.

Each unit is supplied with a 5 year warranty and require no maintenance. They are CE certified and carries the UL safety recognition (file no. E214574) when installed by an approved electrician.

## **Size:**

Available with 2 or 3 heated elements to create medium or large heated areas with a choice of different power outputs.





# Modular *Heaters & LED Lights*

**Our unique modular heaters and LED Lights offer individual combinations for every project.**

They compliment all our canopies, verandas and awnings, are easy to install and waterproof.

Combine single modules or standard sets to every desired colour and length – 10, 20, 30, 50 or 100m.

Choose from our standard colours pure white (9010), Black (9005) and anthracite (7016) or with a supplementary charge for an individual colour of your choice.

Mounting brackets are included whether single modules or standard modular sets.



M1

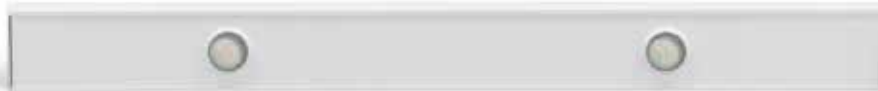

M2



M3



Modular Sets



ANY LENGTH • ANY COLOUR • WATERPROOF • EASY TO FIT



The units simply click together

# Typical product uses

Big Span Canopies



Entrance Canopies



Steel Canopies



Walkway Canopies



Glass Canopies

# Rafter *Bars*

**The Milwood Rafter Bar is a highly versatile aluminium component which can be used to create either curved roofing systems, roof tops for carports or garden canopies.**

They can also be used to re-roof existing structures. It is compatible with 6mm glass, 16mm and 35mm polycarbonate, allowing you to offer a wide range of glazing options without the need for various sized rafter bars, saving on cost and storage space.

This rafter bar is a 2 part aluminium bar with dual gaskets for expansion and contraction of the glazing material.

This bar needs an underside support and will span up to 1.5m (curved from purlin to purlin) and 1m unsupported from purlin to purlin at 2.5 degrees pitch.

The rafter bars are available up to 6m long and are powder coated white as standard and can include F section front and back as part of a roof kit.

*"The kit was easy to self install with minimal parts and a neat finish."*

**MR WIGGINS  
FRINTON ON SEA, ESSEX**

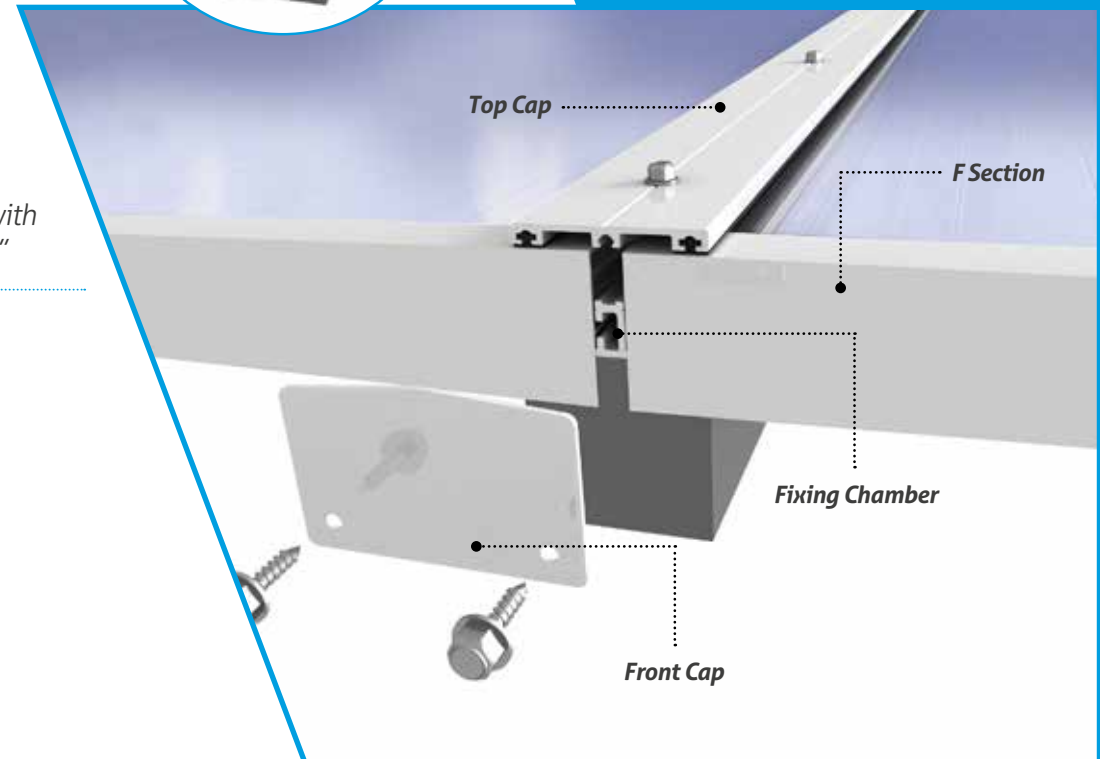



# Bioclimatic *Pergola* Range

## The Creators of the Bioclimatic Pergola

**We have teamed up in partnership with SOLISYSTEME to bring you two fantastic Bioclimatic Pergolas...The REFERENCE and The ELEGANCE.**

SOLISYSTEME is the original inventor of the Bioclimatic Pergola and have been manufacturing these iconic structures since 1998 and to this day is a family run business.

SOLISYSTEME are now world renowned for quality, innovation and durability and held the original patent for the louvered structure from 1998 to 2008, all of their aluminium profiles are subject to the Qualicoat and Qualimarine standards which guarantees quality and durability over time and give an impeccable finish.

The Bioclimatic Concept... The Bioclimatic Pergola is an original and exclusive concept that provides you with an entirely new living space. To be able to quickly shape your environment to enhance your outdoor experience with stylish weather protection, is truly a leap forward...

***Protection...Ventilation...Control...  
Brightness***

### **WARRANTY**

The ELEGANCE and the REFERENCE both come to you complete with a 10 year guarantee on the structures and louvers plus a 3 year guarantee on mechanisms for complete piece of mind.

### **Play with light and shade**

- Customised and scalable aluminium structures
- Manual or motorised versions
- Wall mounted or free standing
- Compatible with a range of accessories
- Can be adapted to all types of architecture
- Rainwater drainage tested up to 230mm/h
- Wind resistance tested up to 180km/h (CSTB)
- Load resistance tested up to 300kg/m<sup>2</sup>



## Take advantage of the best from the outside

The Bioclimatic Pergola invented by SOLISYSTEME is an original and exclusive concept that gives you a whole new living space. Your terrace becomes a real extension of your interior for an outdoor lifestyle. Temperature, freshness or sunshine intensity can be modulated to suit your mood or to tame the weather. You can naturally adjust the ambience of adjoining rooms simply by regulating the rays of the sun.

Based around our REFERENCE structure, you will benefit from an understated, modular, robust and elegant finish. It fits perfectly into classic, modern or avant-garde architecture. You will be able to prolong your evenings by creating beautiful nocturnal atmospheres with our new integrated LED lighting.



**PROTECTION**  
*Protects from harmful sunlight and offers complete cover from poor weather conditions.*



**VENTILATION**  
*Provides ventilation to prevent hothouse heat build-up whilst retaining shade.*



**CONTROL**  
*Regulates the temperature of adjoining rooms by controlling sunlight intensity and direction.*



**BRIGHTNESS**  
*Adjusts the intensity of the daylight to enable enjoyment of low-light hours.*



option 1



# The **REFERENCE** Pergola

The REFERENCE is the most cost effective Bioclimatic Pergola that we offer, we have a large range of standard structures within the range and bespoke sizes available.

**Maximum distance post to post is 7150mm  
Blades are up to 4m long**

There are also 4 lighting options consisting of LED spots, integrated downlight strips inside of the beams, strip light up lighting options and an effective gutter strip lighting system.

## Colours Options

All standard fixed size pergolas are supplied either in RAL 9010 White or RAL 7016 Grey for the frame or the louvers.

## Optional Upgrades

- Lateral Zip Screens with Somfy motors
- Sliding glass panels
- Integrated LED strip or spot lighting
- Adjustable vertical Brise Soleil shading options
- Heaters

*Roof blade units can be joined together to create unlimited length and width*



RAL 9010 RAL 7016

All bespoke pergolas are available in 9 standard colours for the frame and either RAL 7016 grey or RAL 9010 white for the louvers.



RAL 9010 RAL 7016 RAL 9005 RAL 7037 RAL 9006

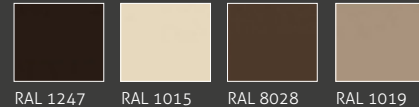

RAL 1247 RAL 1015 RAL 8028 RAL 1019



SUITABLE FOR GARDEN & DINING AREAS



SUITABLE FOR COMMERCIAL GARDENS

**2**  
*option*





# The **ELEGANCE** Pergola

Enjoy your stylish terrace in all weathers with its clean lines and unique design, the ELEGANCE will create a genuine outdoor living space in any weather.

**Maximum distance post to post is 7225mm**  
**Blades are up to 4m long**

The ELEGANCE finish offers a truly customisable peripheral frame and creates a truly personal look, choose from a range of standard laser cut designs to enhance the structure.

- **Hidden hardware and fasteners**
- **Innovative posts for the integration of electronic components**
- **Compatible with all the standard Bioclimatic accessories**
- **Integrated LED strip lighting**
- **Standard or bespoke laser cut options**

*Roof blade units can be joined together to create unlimited length and width*

## Colours Options

All standard fixed size pergolas are supplied either in RAL 9010 White or RAL 7016 Grey for the frame or the louvers.



All bespoke pergolas are available in 9 standard colours for the frame and either RAL 7016 grey or RAL 9010 white for the louvers.



SUITABLE FOR GARDEN  
& DINING AREAS



SUITABLE FOR  
COMMERCIAL GARDENS



Zip Screens

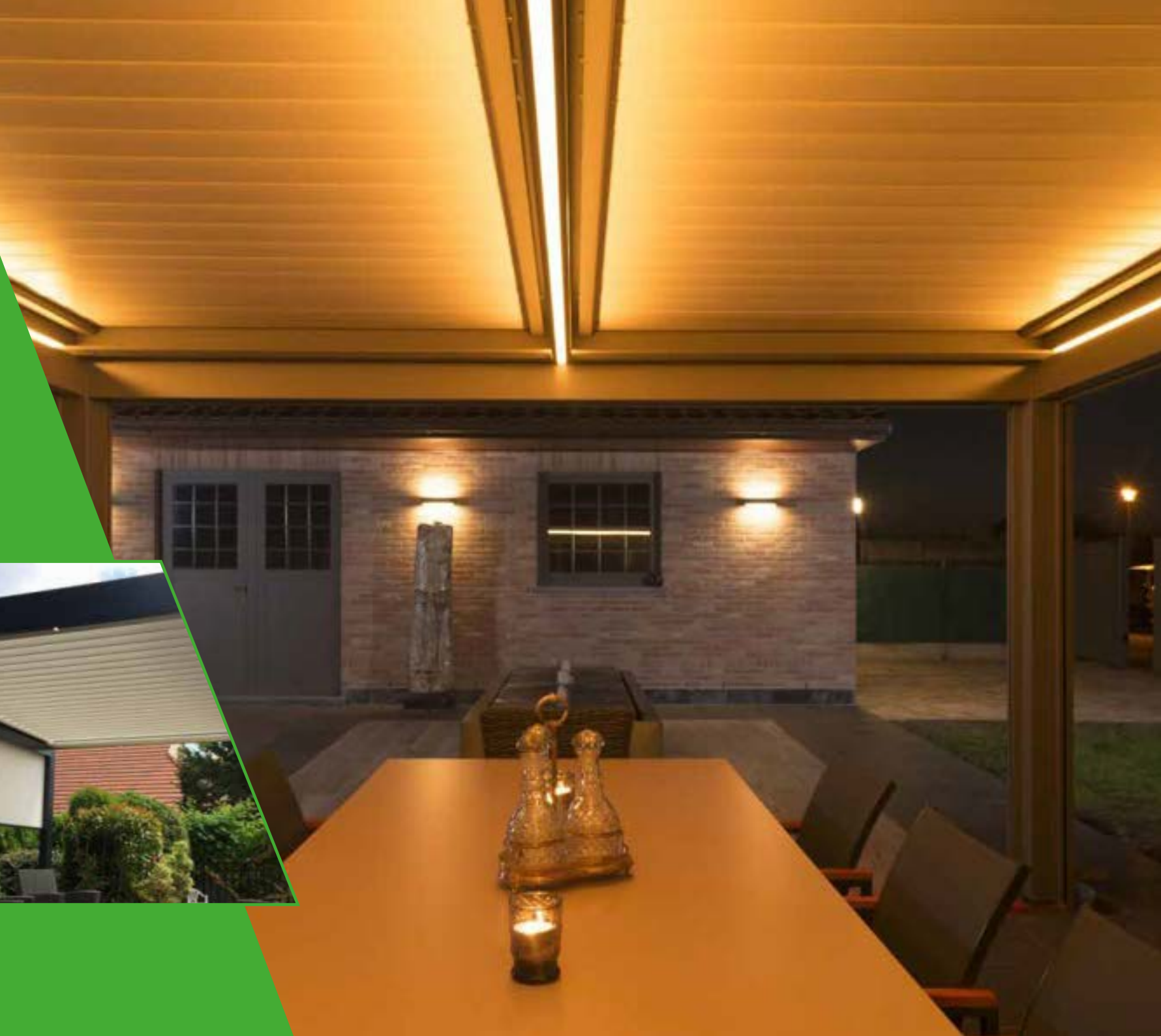

# Pergola Accessories

Your terrace is ready for the summer but who said that your Pergola was only for the summer season?

Our options for customisation lets your customers enjoy their terrace every day of the year, whatever the season. Glass walls, side blinds, lighting, heating or a fireplace - you can be outside with all the creature comforts of being inside.

No matter if it's hot or cold outside, your customers can still be in their garden enjoying even the slightest rays of sunshine. With the remote control in hand, the accessories of their pergola will obey their every command to master the elements.

## Optional Upgrades

- Lateral Zip Screens with Somfy motors
- Sliding glass panels
- Integrated LED strip or spot lighting
- Adjustable vertical Brize Soleil shading options
- Heaters



Spot Lighting

## Pergola Formats



Inclined structure



Self-standing

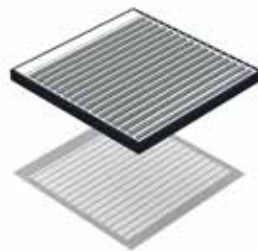

Built-in structure



Wall mounted



LED Strips

# The *Retractable* Verandas

A retractable veranda gives you the choice of shelter from the elements and the freedom of the skies.

With 2 fantastic retractable options to choose from, The Pergolino and the Mini 90.

The Pergolino is designed for shade from the sun and is available in 3 colours to match most surroundings. Available up to 5m projection and 5m bays to enable you to go any length, it is quick to install and looks stunning. These structures come complete with Somfy motors and controls for peace of mind.

Our retractable Mini 90 veranda uses a durable PVC fabric that can withstand all weathers so is the ideal alternative for when glass or polycarbonate is not desired.

This motorised roof can be set at any point on the guide rails to give you complete control of how much shade or rain protection you require, maximising your comfort in your outdoor area.

With a wide range of upgrades available and four beautiful colours as standard, this product will not only enhance your home, but also your enjoyment of your home.

The mini 90 is capable of covering some impressive dimensions with minimum fuss and material so you can still maximise your garden or commercial area.

There are fantastic lighting options that allow you to enjoy the product all day and night as well as all year round in the form of spot or strip LED's in a choice of white or RGB if you fancy something a bit different. For extra protection from the elements, the Skipper vertical blind is a fantastic upgrade that can be added to all 3 side to create a garden room that is both attractive and versatile.

Our retractable verandas will not only enhance your home, but also your enjoyment of your home.



# 2 options

Your terrace becomes a real extension of your interior for an outdoor lifestyle.



*The Mini 90*



*The Pergolino*

Our retractable Mini 90 verandas have fantastic lighting options that allow you to enjoy longer evenings.





# The *Mini 90*

Mini 90 is a retractable awning, custom made from aluminum for sun and rain protection. The structure may be fixed to the wall or the ceiling with stainless steel brackets.

The wind resistance is guaranteed up to a minimum grade 6 on the Beaufort scale (class 3 - UNI EN 13561: 2009, EN 13782: 2006 and the Structural Eurocodes). The Mini 90 version with 4 runners achieves a maximum width of 14 meters. And a projection of 5.5 meters at 12 metres long. The fabric is mounted on intermediate profiles that slide on rollers housed inside the runners and is driven by a motor with a steel stranded pulley belt.

The handling system takes place via a tubular Somfy motor with coaxial transmission, which allows for greater ease of assembly and maintenance.

PVC profiles that prevent the water ingress are provided as a standard on all runners. The structure is available in exclusive anthracite, white RAL9016, ivory RAL1013 and brown RAL8017; intermediate profiles in white and ivory. Accessories are made of stainless steel AISI 304 and the aluminum awning protection covers are painted to match the structure.

Furthermore Mini 90 is fitted with a standard aluminium gutter that allows to fix the runners internally with special brackets.



## Colours Options

All standard Mini 90 frames are supplied either in ANTRA24 Anthracite Grey, RAL 9016 White, RAL 8017 Brown or RAL 1013.

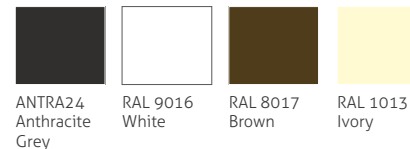

SUITABLE FOR GARDEN  
& DINING AREAS



SUITABLE FOR  
COMMERCIAL GARDENS

## Benefits

### A ROBUST AND RELIABLE MOTOR

Mini 90 uses the best tubular motor series Somfy Pergola iO, which is installed as standard.



### A GABLE DESIGNED TO MAXIMISE THE WEATHER PROTECTION

The gable profile is designed to adapt to different kinds of infill: fabric, Cristal Clear or PVC, or a rigid material like polycarbonate.



### SIDE BEAM TO THE GUTTER

By installing a side beam this allows you to install side screens for extra weather protection.



### QUICK AND SAFE CONNECTION FOR WALL MOUNTING

A buttonhole in the upper part of the wall bracket allows the quick coupling of the runner. Therefore the Mini 90 is quick and safe to install.



The Skipper horizontal screens give perfect protection from the elements.

### GREAT COVERAGE

The size of the structure reaches a maximum width up to 14m with a projection of 4m and 12m at 5.5m projection.

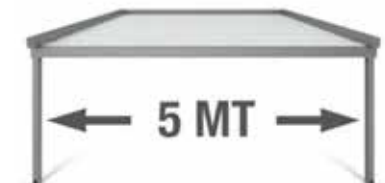



# Views

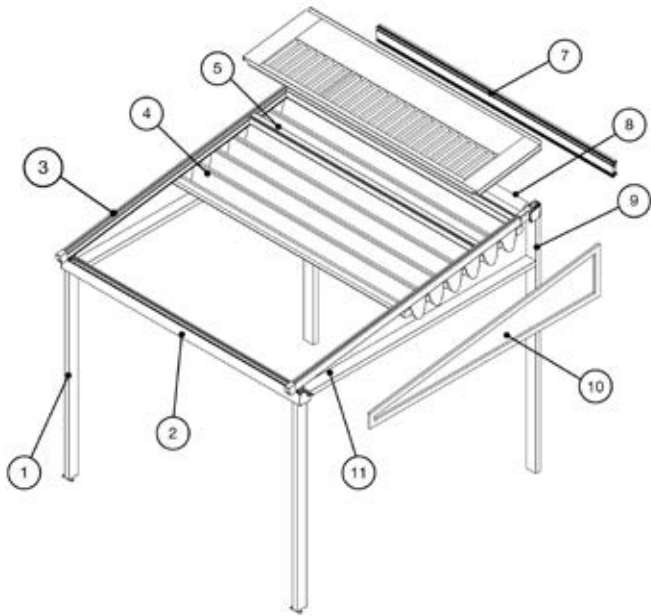

- 1. Pillar
- 2. Gutter
- 3. Runner
- 4. Fabric Cloth
- 5. Awnings Protection Cross Beam
- 6. Awning Protection
- 7. Additional Wall Beam (optional)
- 8. Transmission Group
- 9. Wall Pillar (optional)
- 10. Gable (optional)
- 11. Side Beam (optional)

**3 Runners**

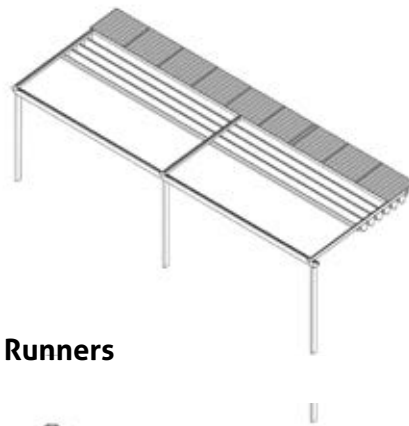

**4 Runners**

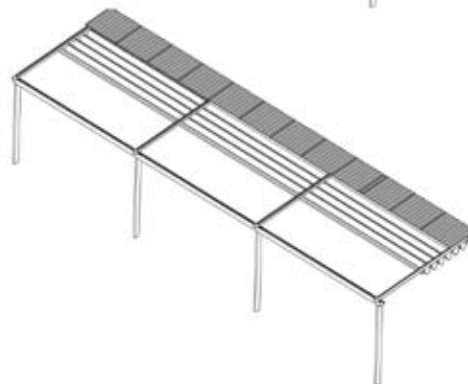



# The *Skipper* Plus 500 Horizontal Side Screens

Skipper 500 is a vertical roll-up closure with zip system on the side runners, which makes it suitable for protection from sun, rain and wind.

The structure is made of aluminum and is guaranteed up to grade 7 on the Beaufort scale up to 350cm x H 250 cm (class 3 - UNI EN 13561: 2009, EN 13782: 2006 and the Structural Eurocodes).

Skipper 500 has an easy access housing and is equipped with an outer upper seal, that is suitable for the perfect alignment of the profile with the ceiling.

The runners, with a spring compensation mechanism, allow the structure to adapt to alterations in width and stress suffered by the cloth up to 4 cm.

The type of fabric depends on the size of the structure and may reach up to a maximum width of 5.5m and a maximum height of 3.5m. Skipper 500 can be moved by manual with a crank handle, or motorised for ease of use.



## Colours Options

All standard Mini 90 frames are supplied either in ANTRA24 Anthracite Grey, RAL 9016 White, RAL 8017 Brown or RAL 1013.

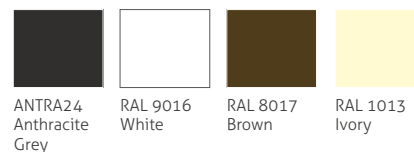

SUITABLE FOR GARDEN  
& DINING AREAS



SUITABLE FOR  
COMMERCIAL GARDENS

# Skipper 500 Modular

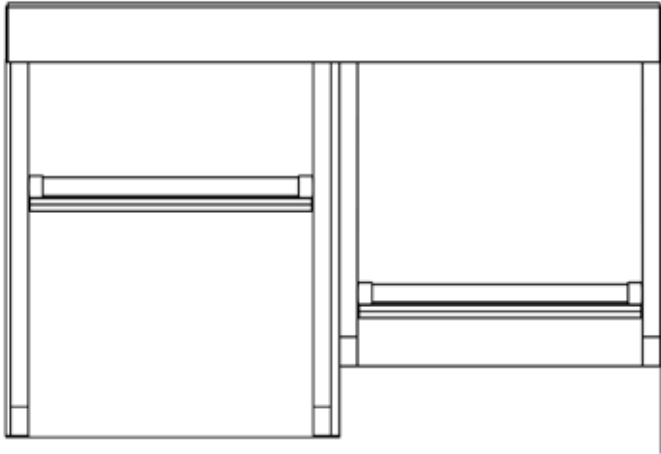

**Solution with 2 modules at different heights**

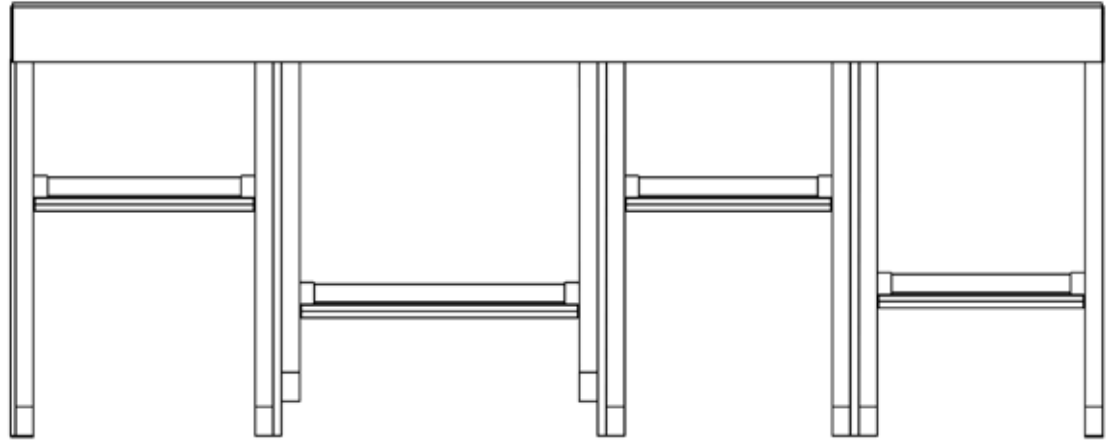

**Solution with 4 modules at different heights and widths**

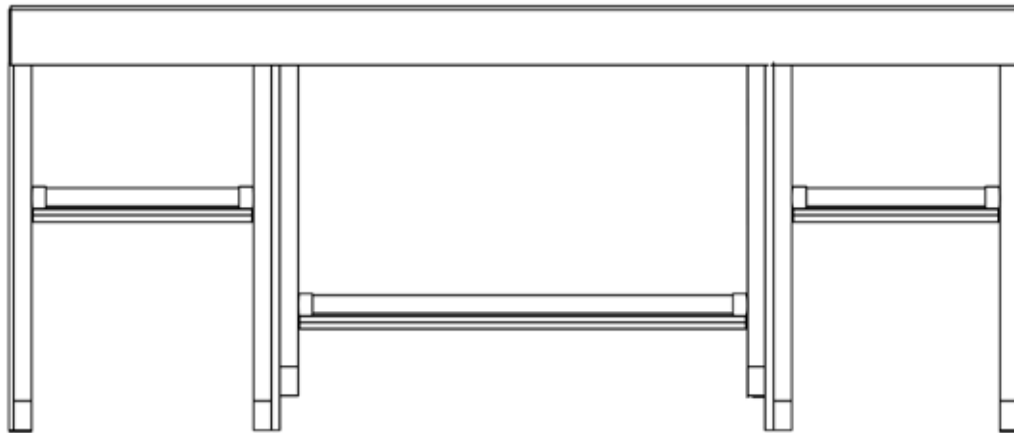

**Solution with 3 modules at different heights and widths**

Max overall dimensions: L 600 x H 350 cm  
Max dimensions per single module: L 500 cm

# Views

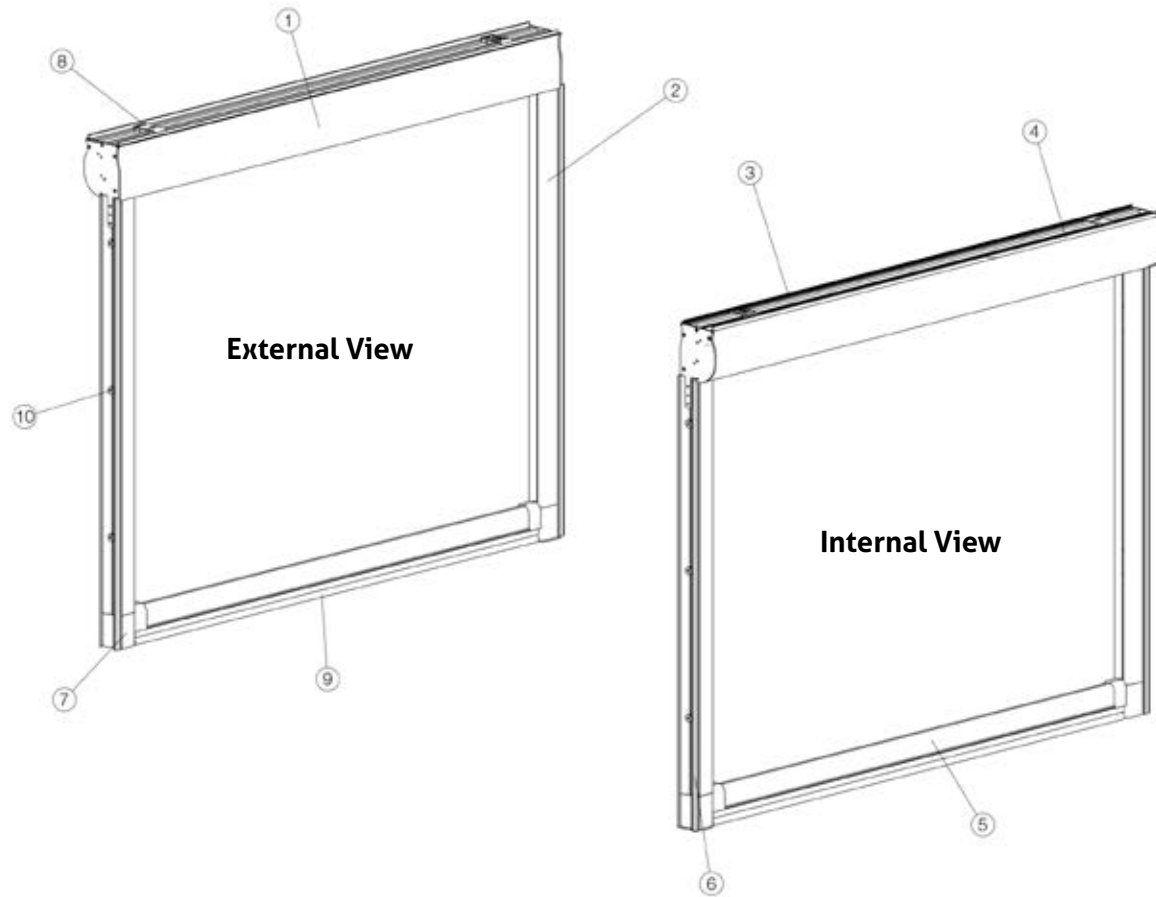

- |                         |                              |
|-------------------------|------------------------------|
| 1. Housing              | 6. Lateral Seal              |
| 2. Runners              | 7. Locking Mechanism         |
| 3. Upper External Seal  | 8. Overhead Anchorage        |
| 4. Upper Internal Brush | 9. Bottom Seal               |
| 5. Bottom               | 10. Telescopic Screw Bushing |



# The Pergolino

The Pergolino provides protection from bright sunshine as well as light rain and is the ideal solution for restaurants, bars and cafes as well as domestic properties. The pergolino can project up to 5m projection and any length.

## Stability

Due to its high quality and robust construction using the best components, the Pergolino is a very stable structure.

## Comfort and protection

Summer rain will never again surprise the guests of restaurants or families at a weekend barbecue. Your customer may enjoy additional space around their home, protected from sun, wind and rain.



## Wide range of colours

Choose from our extensive range of colours. Standard colours can be found on page 99 and for additional colours please visit our website.

## Thermal gluing of fabrics

The fabric is bonded together with a modern hot glue technique using only the highest quality PUR-based reactive glue.

**Each Pergolino awning comes with a 2 year guarantee, 5 years warranty on fabric and 5 years on Somfy motors (all subject to terms and conditions).**

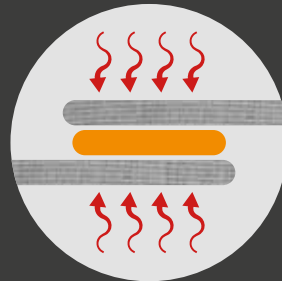

SUITABLE FOR GARDEN & DINING AREAS



SUITABLE FOR COMMERCIAL GARDENS

# The *Awning* Range

**The Milwood Group offer a range of high end retractable awnings. These are designed to complement the other fixed glass and polycarbonate solutions we have. Using only the finest Somfy Motors and Dickson Fabrics, they are designed to last in the commercial and domestic markets.**

## **The Palladio**

The Palladio is a stylish awning which retracts into a compact cassette when not in use. The neat design ensures the Palladio is unobtrusive but can be easily and quickly extended to create shade during sunny weather or offer shelter from wind and rain.

## **The Nordic**

The Nordic awning fits seamlessly into any setting, creating shade and shelter in even the most adverse weather. It can also be configured with an added feature of being able to adjust the inclination of the awning, which is useful depending on the angle of the sun at different times of the day.

## **The Heston**

The Heston is our luxury awning range that is capable of impressive spans and projections. It comes in an attractive array of colours and uses cutting edge Para Tempotest Starlight fabric for durability and protection from the sun and light rain.

## **The Apollo**

The Apollo Awning is a back to back, multi-purpose awning suitable for large outdoor areas.

## **The Screener Veranda**

A solid and elegant awning that is designed to be installed on to a veranda or other large vertical or horizontal glazed area.

## **Window Awning**

Window awnings are an ideal solution for detached houses, restaurants, cafés and small shops. It protects against penetration of sunlight. Moreover, it decorates a building and is easy to use with its perfect functioning system provided by high quality manual or electric drive.

*Outdoor spaces always present a challenge of form or function, we need to make sure you have a variety of different options and solutions to suit any environment or customers expectation.*

*The awning range allows you to offer retractable solutions in a range of sizes, shapes and colours to meet most requirements.*



# 6 options

Our retractable awnings are designed to compliment the other solutions we have.



*The Palladio*



*The Nordic*



*The Heston*



*The Apollo  
Awning*

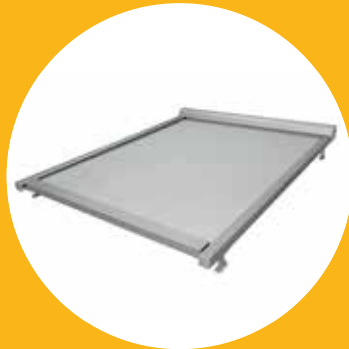

*The Screener  
Veranda*



*The Window  
Awning*





# The *Palladio*

The Palladio is a stylish awning which retracts into a compact cassette when not in use. The neat design ensures the Palladio is unobtrusive but can be easily and quickly extended to create shade during sunny weather or offer shelter from wind and rain.

## Precision

High quality design ensures smooth and reliable operation of the flyer chain within the arm. We also ensure the fabric is stretched evenly by using special tensioning mechanisms.

## Wide range of colours

Choose from our extensive range of colours. Standard colours can be found on page 99 and for additional colours please visit our website.

## Automatic options

Choose the automation that suits your requirements with our intelligent solar or wind sensor options.

## Fabric protection

Our unique design means our awnings are tightly rolled and completely protected inside the cassette.

## Thermal gluing of fabrics

The fabric is bonded together with a modern hot glue technique using only the highest quality PUR-based reactive glue.

## Vario Volant

Vario Volant is an unrolling ruffle, which is discreetly concealed in the front section of the awning. It provides protection against the low sunset and guarantees privacy and comfort. It can be used both with the Palladio and Nordic awnings.

**Each Palladio awning comes with a 2 year guarantee, 5 years warranty on fabric and 5 years on Somfy motors (all subject to terms and conditions).**

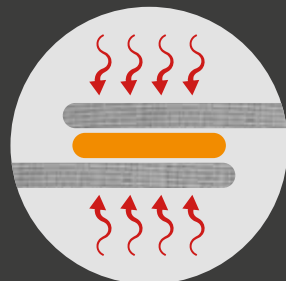

SUITABLE FOR GARDEN  
& DINING AREAS



SUITABLE FOR  
COMMERCIAL GARDENS



# The *Nordic*

The Nordic awning is available 7m long x 3.6m projection and fits seamlessly into any setting, creating shade and shelter in even the most adverse weather. It can also be configured with an added feature of being able to adjust the inclination of the awning, which is useful depending on the angle of the sun at different times of the day. The Nordic is a popular choice for all environments due to its elegantly simple design and robust construction.

## Precision

By creating a shaded and sheltered outdoor area you can protect your expensive garden furniture which can quickly deteriorate if left to the elements.

## Control options

Choose the best automatic control options to suit your needs. Optional sunlight and wind sensors as well as the ability to manually alter the inclination of the awning.

## Wide range of colours

You can choose from a vast range of colours depending on whether you want the awning to blend in, or contrast with

the existing architecture and surroundings. Standard colours can be found on page 99 and for additional colours please visit our website.

## R-Pitch

R-Pitch is an additional option for the Australia awning which enables the inclination of the awning to be manually adjusted with the use of a crank.

## Thermal gluing of fabrics

The fabric is bonded together with a modern hot glue technique using only the highest quality PUR-based reactive glue.

## Vario Volant

Vario Volant is an unrolling ruffle, which is discreetly concealed in a front section of the awning. It provides protection against the low sunset and guarantees privacy and comfort. It can be used both with the Palladio and Nordic awnings.

**Each Nordic awning comes with a 2 year guarantee, 5 years warranty on fabric and 5 years on Somfy motors (all subject to terms and conditions).**

Optional protective aluminium hood



SUITABLE FOR GARDEN  
& DINING AREAS



SUITABLE FOR  
COMMERCIAL GARDENS



# The *Heston*

Our latest awning range consists of 3 variants, the Heston Light, Heston Flat and Heston Pro, each with their own unique characteristics. This beautiful awning range is capable of impressive spans and projections whilst the contemporary design will complement a wide range of homes and buildings. With a wide range of upgrades and colour options, there is something for everyone with a Heston awning.

## Precision

Each awning is hand built to your specification using only the finest materials and components. The Somfy motors are the industry benchmark and come with a 5 year guarantee. The pitch is adjustable so you can tailor the drop of the awning to suit your individual requirements and the sun position of your home.

## Control options

Manual or motorised options are available throughout the range and one remote control can operate multiple awnings and upgrades.

## Colours

There are four standard colours throughout the range and these can be combined to create a personalised product for your home as well as one to perfectly match its surroundings. The fabric options are a blend of contemporary and classic shades and designs.

## LED

LED lighting is available throughout the range and can be positioned in the awning arms and cassette to give your outdoor living area the comfort and versatility to use all day and into the night.

**Each Heston awning comes with a 2 year guarantee, 5 years warranty on fabric and 5 years on Somfy motors (all subject to terms and conditions).**



SUITABLE FOR GARDEN  
& DINING AREAS



SUITABLE FOR  
COMMERCIAL GARDENS



For Colour  
Combinations  
& Fabric  
Colours see  
page 93

## The *Heston Light*

The entry level Heston is capable of 6m length and 3.6m projection. Housed in a modern satisfyingly neat design that is sharp, square and modern, this is the perfect awning for the discerning customer.

With the addition of LED lighting in the awning arms, this is an attractive and versatile addition to any home or building.

It can be fully retracted when not in use and can be covered with up to 28 different fabric colours and 4 different frame colours.







## The *Heston Flat*

The Heston Flat is the first of the big span awning options and is capable of 12 length in one roll of fabric and a projection of 3.6m which gives a lot of scope for large houses and commercial buildings.

The cassette shape is simple and contemporary and doesn't require a lot of landing space on the wall so is ideal for all applications. LED lighting is available in both the cassette and awning arms to enhance the covered area.

**For Colour  
Combinations  
& Fabric  
Colours see  
page 93**





For Colour  
Combinations  
& Fabric  
Colours see  
page 93

## The *Heston Pro*

This awning has the capability of a 12m length in one roll of fabric and a 4.35m projection which is truly amazing.

The well thought out design of the cassette box complements any home or building and as with all the Heston range, fully encloses the fabric to preserve and protect it from the elements.

Like the Heston Flat, you can add the LED lighting to the cassette as well as the awning arms for complete versatility.



# The *Heston* Accessories

The Heston comes in an attractive array of colours and uses cutting edge Para Tempotest Starlight fabric for durability and protection from the sun and light rain. For colours available see also see page 93 or visit: [www.milwoodgroup.com/awnings/](http://www.milwoodgroup.com/awnings/)

The cassettes are fully enclosed to preserve the fabric and allow for a sleek and contemporary design. They come in 4 standard colours and any combination of - see below..

Each awnings boasts useful upgrades such as integrated LED lighting and Bluetooth speakers that will really enhance your enjoyment of the product.

## Casette Colours



LED lighting on the awning arms



# The *Heston* & *Apollo* Colours

## Colour Combinations



When ordering please specify colour combination code (e.g. C7)

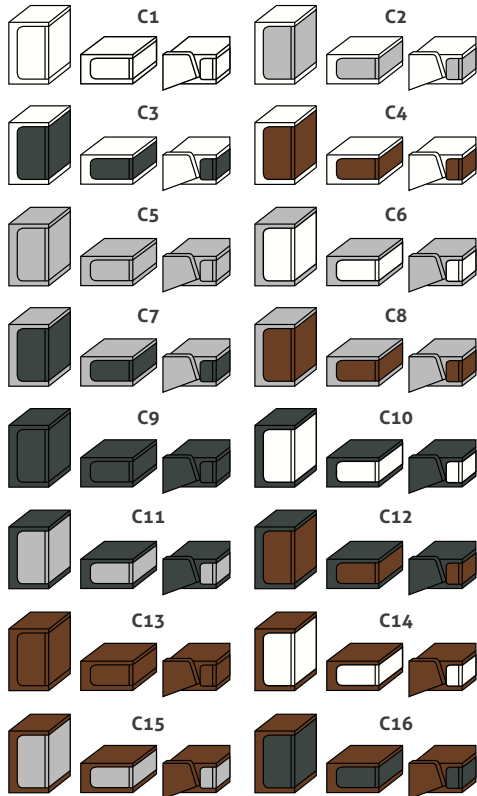

## Fabric Colours

STARLIGHT is a line of fabrics produced with an innovative 100% PET fibre dyed in the mass with added UV Absorbers to makes them perfectly stable and resistant to UV rays. The fabrics have an outstanding resistance to deformation and traction, making them especially suited for use in large

structures, sails with fabric that have hanging brackets that are subject to a high degree of traction and box awnings. When used for basket awnings these fabrics significantly reduce the risk of micro-perforations due to the mechanical action of opening and closing.



option 4



# The *Apollo*

Introducing the all new free standing, back to back, multi-purpose, versatile awning...The Apollo Awning.

Perfect for large outdoor covered areas in either a commercial or domestic setting, available in a standard RAL 9010 but also in any RAL colour at an additional cost.

This impressive awning is available at 5.5m wide and 6.2m total projection and both sides operate simultaneously.

The Apollo is a back to back awning which is perfect for shade from the sun in large areas with no walls to fix to.

## Features

- Total length max is 5.5m from post to post, with a projection of 3.1m both sides to make 6.2m in total.
- 1 standard colour for the frame but any other colour is additional charge
- Maximum pitch 30 degrees
- Posts can be between 2.5m up to 3m in height
- Dixon fabric
- Standard Somfy RTS motors and Somfy remote controls
- Optional Valance
- Optional inground support brackets

**Each Apollo awning comes with a 2 year guarantee, 5 years warranty on fabric and 5 years on Somfy motors (all subject to terms and conditions).**



**For Colour  
Combinations  
& Fabric  
Colours see  
page 93**



SUITABLE FOR GARDEN  
& DINING AREAS



SUITABLE FOR  
COMMERCIAL GARDENS

option **5**





# Screener Veranda

A solid and elegant awning that is designed to be installed onto a veranda, glass room or other large vertical or horizontal glazed structure.

## Precision

The Screener Veranda has a specially designed traction bar to guarantee constant fabric tension in any position.

## Convenience

The Screener Veranda ensures efficient air circulation and optimal sun protection which minimises overheating.



## Fabric colours

### Soltis 92 Colour Range:

<b>Weight:</b>	420 g/sqm
<b>Thickness:</b>	0.45 mm
<b>Roll-width:</b>	177 cm
<b>Tensile Strength (warp/weft):</b>	310/210 daN / 5cm
<b>Tear Resistance (warp/weft):</b>	40/20 daN
<b>Flame Retardancy (warp/weft):</b>	M1/NFP 92-507 • METHOD 1/NFPA 701 • CSFM T19 • CLASS A/ASTM E84 B1/DIN 4102-1 • BS 7837 • BS 5867 • LASSE 1/UNI 9177-87 • M1/UNE 23.727-90 • VKF 5.2/SN 198898 • 1530.3 /AS/NZS 1530.3 • G1/GOST 30244-94
<b>Euroclass:</b>	B-s2,d0/EN 13501-1
<b>Quality Management System:</b>	ISO 9001

The technical data shown here are average values, given for information only, and may be modified.



SOLTIS 92-2046  
ALU/OAT



SOLTIS 92-2171  
BOULDER



SOLTIS 92-2048  
ALU/ALU



SOLTIS 92-2045  
BEATEN-METAL



SOLTIS 92-2074  
ALU-MEDIUM  
GREY



SOLTIS 92-2167  
CONCRETE



SOLTIS 92-2047  
ANTHRACITE



SOLTIS 92-2053  
BLACK

**Serge Ferrari**



# Window *Awnings*

The stylish and simplistic Window Awning has been designed to create shade and shelter to your customer's homes. It is made completely from aluminium and high quality Dickson fabric. The customer is given the choice of manual or electronic operation at the time of ordering to suit their needs.

*"Really happy with our awning, it was the best thing we could have done, it has transformed the side of the bungalow and my husband said your installers did a great job"*

MRS. ROSALYN GILES  
ALDERSHOT, HAMPSHIRE

The precise design ensures the Window Awning is unobtrusive, and can be easily and quickly installed to create instant shade. It is the perfect window shade solution for detached houses, restaurants, cafés and small shops.



6  
option



SUITABLE FOR GARDEN  
& DINING AREAS



SUITABLE FOR  
COMMERCIAL GARDENS

# Standard Fabric *Colours*



For the Palladio, Australia, Pergolino & Window Awnings

## Dickson Colour Range:

**Composition:** Acrylic 100%, solution dyed  
**Finishing:** Cleangard special dirt-resistant and awning water repellent treatment  
**Weight: 290g/m2 Width:** 120cm  
**Tensile Strength:** 140 daN Wrap / 90 daN Weft  
**Tear Strength:** 4 daN Wrap / 2.3 daN Weft  
**Water Repellency:** >370mm  
**Colour Fastness Weather Condition:** 4-5 / 5



## Standard Construction Colours



# The *Umbrella* Range

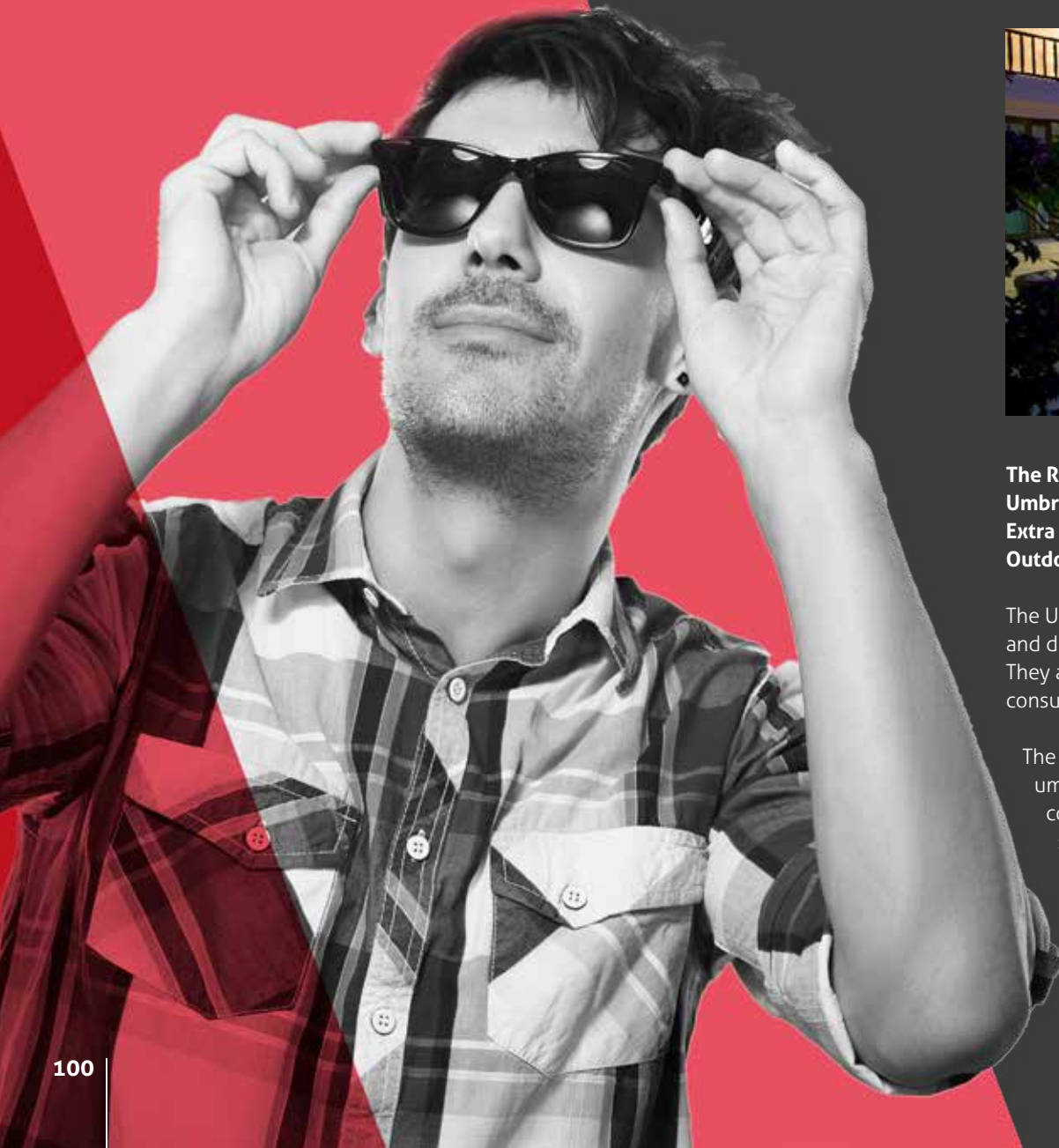

**The Range of Umbrellas consists of Giant Umbrellas, Large Commercial Umbrellas, Extra Large Patio Umbrellas and Large Outdoor Umbrellas.**

The Umbrella range combines style, quality and durability for all types of application. They are engineered and manufactured for consumers who demand the best.

The Classic, Strongwind and Cantilever umbrellas are ideal for any domestic or commercial area and will give you the shade and weather protection you require.

The Giant and Impressive Umbrellas provide a great solution to protection from the elements for a variety of domestic or commercial applications. Whether it be for a garden, hotel, restaurant, pub or resort, these umbrellas will enhance the customer experience in all weathers.

All structures, apart from the Cantilever Umbrella come with a large range of accessories from side panels, heaters, lights and gutters.

# 6 options

All Structures come with a large range of accessories from side panels, heaters, lights, and even gutters if required.



*Classic*



*Giant*



*StrongWind*



*Cantilever*



*Impressive*



*Marine Upgrade*





# The *Classic* Umbrella

**Our stylish Classic Umbrellas offer the ideal shade and protection with timeless styling, unrivaled quality, reliability and durability.**

They create the perfect ambiance while providing a comfortable and protected outdoor environment. Popular in the hospitality industry, they are also the choice of commercial and residential customers who demand top quality at reasonable prices.

The Classic Umbrellas are available in round, square and rectangular shapes in 41 sizes. Our Classic Umbrellas are ideal for small to medium shade solutions from 4 to

The Classic range of umbrellas can be supplied with protective covers, heaters, portable bases and in ground options.

**Sizes range from 4m<sup>2</sup> up to 27.5m<sup>2</sup>**  
**Available square rectangular or round**

27.5 square meters (43 to 280 square feet.)  
Custom sizes are also available on request.

Built with a strong mast and eight strong arms, these telescopic center post umbrellas provide maximum functionality and stability. Easy and safe to operate, these smaller, but commercial quality umbrellas are the choice of individuals and businesses that demand strong, but elegant shade solution.



Heaters available  
See page 98



SUITABLE FOR GARDEN  
& DINING AREAS



SUITABLE FOR  
COMMERCIAL GARDENS

option 2





# The *Giant* Umbrella

**The Giant Umbrellas are the giants of the umbrella world. These telescopic umbrellas are strong and stable with post diameter and wall thickness of 110/5mm.**

Manufactured with 10 or 12 strong arms, these telescopic umbrellas also have a allen crank that makes operating these extra large umbrellas very easy.

Our Giant Umbrellas are the perfect choice to shade medium to very large areas. They are large enough to cover an entire patio and provide a safe oasis from rain and shine. The area covered by these giant umbrellas ranges from 36 to 78m<sup>2</sup> (or 350 to 845 square feet).

**Sizes range from 36m<sup>2</sup> up to 78m<sup>2</sup>  
Available square, rectangular or round**

Adjacent square or rectangular umbrellas can be connected to cover extremely large areas.

As for our other models, these umbrellas come with optional accessories like rain gutters and side panels that offer complete weather protection, lights and heaters to raise ambience and comfort levels.

The Giant range of umbrellas can be supplied with protective covers, heaters, portable bases or in ground options. You can also add individual sidesheets to each side of the umbrella. These can be connected together to create an enclosed space. Also, clear sections can be added for transparency.



SUITABLE FOR GARDEN  
& DINING AREAS



SUITABLE FOR  
COMMERCIAL GARDENS



# The *StrongWind* Umbrella

The StrongWind Umbrellas are in a class of their own. Their unrivaled strength is combined with beauty and sophistication that is presented with meticulous workmanship.

In a TUV certified wind tunnel testing, the StrongWind passed 102 kilometer (60 miles) per hour sustained wind by a large margin, providing proof that our StrongWind umbrellas are the ultimate choice for extremely windy locations. The actual wind speed of 120km or 75mph reached during our test is Hurricane level 1 wind. The StrongWind Umbrella can resist wind speeds of up to 70 km/h.

Our StrongWind Umbrellas perform exceptionally well under any weather conditions, and are unrivaled in value. They are very popular in the hospitality industry. Many hotels, restaurants, cafés, pubs and resorts rely on StrongWind Umbrellas for their brute strength, and municipal parks, pool complexes and theme parks install them for their proven stability.

## Benefits

- Extra Strong Robust Design
- Can be used in wet and windy conditions
- Available in round or square designs

Sizes range from 7m<sup>2</sup> up to 50m<sup>2</sup>

*"My husband and I are getting to our later years in life, so we thought we needed that extra bit of shade in the summer. These umbrellas provided the perfect solution! Easy to use, simple to clean and do a great job of protecting us from the sun. Highly recommend."*

**MRS. JOHNSTON**  
**KENT**

The StrongWind range of umbrellas can be supplied with protective covers, heaters, portable bases and in ground options. You can also add individual sidesheets to each side of the umbrella. These can be connected together to create an enclosed space. Also, clear sections can be added for transparency.



SUITABLE FOR GARDEN  
& DINING AREAS



SUITABLE FOR  
COMMERCIAL GARDENS



# The *Cantilever* Umbrella

**The Cantilever Umbrellas create a one-of-a-kind outdoor oasis in any outdoor setting. The side posts are sleek, elegant, strong and functional. The elegant profile is eye-catching open and closed.**

There's no central post to interrupt floor space, so these sophisticated looking quality umbrellas are ideal for the hospitality industry as well as for residential applications. The seven arm telescopic technology allows easy operation of our "offset" umbrellas.

Cantilever umbrellas are best suited to provide shade for small to medium size

Sizes available are 3.0 x 3.0, 4.0 x 4.0, 5.0 x 4.0m, with mast diameter of 110mm and a 5mm material thickness. The 5.0 x 5.0m has a mast diameter of 125mm and a 10mm material thickness.

areas. To take full advantage of their strength, we are recommending them for permanent, in-ground installation.

*"All I've got to say is, Value for money! Good quality, provides a tone of shading and very affordable. Can't go wrong with this product."*

**MR. JACOBS  
SWINDON**



SUITABLE FOR GARDEN  
& DINING AREAS



SUITABLE FOR  
COMMERCIAL GARDENS



# The *Impressive* Umbrella

A stunning eye-catching umbrella the Impressive Type TXV is a reliable cover solution offering truly unbeatable shade.

When fully open this Umbrella provides large shading for playgrounds, market stalls, parks, open-air events, waterfront places and anywhere where cover is required to achieve a pleasant place to stay.

## Benefits

- Extremely robust giant umbrella with reinforced components
- Ideal for shading large sized areas
- 12-arm telescope technology

Sizes available are 6.5m and 7m, with mast diameter of 111mm and a 7mm material thickness.

## Specifications

**Size :** 6.5m x 6.5m or 7m x 7m

**Shaded area:** 42.3m<sup>2</sup> - 49m<sup>2</sup>

**Mast:** 111mm

**Mast thickness:** 7mm

**Arms:** 56 x 31 x 2.5mm

**Operation:** Crank handle and crank pin

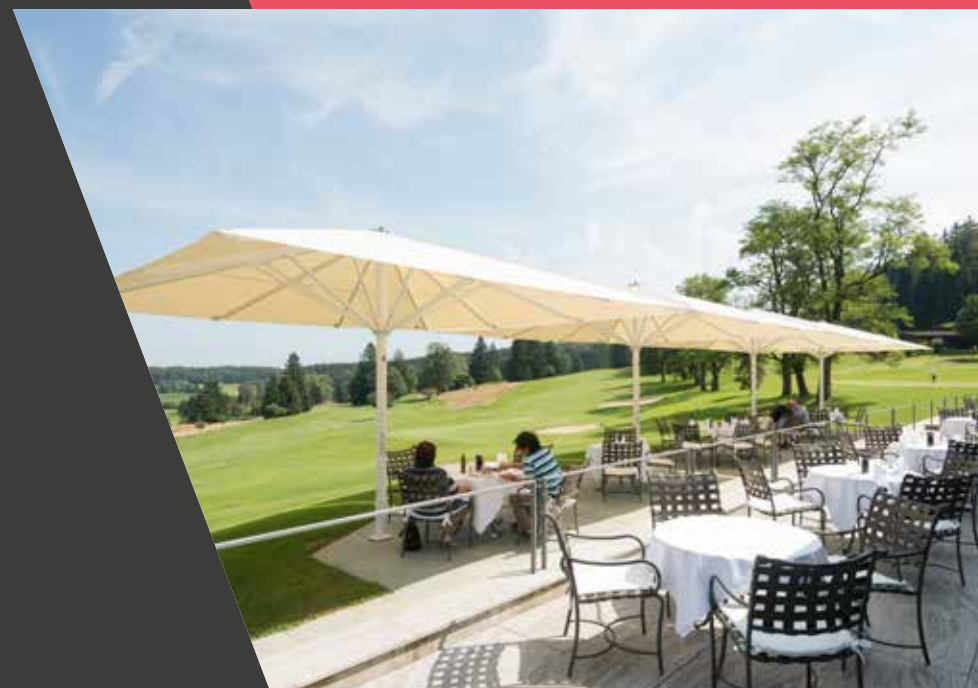

SUITABLE FOR GARDEN  
& DINING AREAS



SUITABLE FOR  
COMMERCIAL GARDENS

option **6**





# The *Marine* Umbrella Upgrade

**The salty fog and mist that lingers along the sea does more damage to umbrellas than any other elements combined. It clogs the umbrellas driving mechanism and rusts the nuts and bolts. The Marine Upgrade has been designed to prevent these problems.**

We use military grade sealant and lubricants that make our gear-box and spindle pipe air tight, preventing the salt to get into those critical areas. The eye-screws and hinges are double galvanized, the joints are stainless steel to prevent rusting. The powder coating on the aluminum frame

also prevents rust damage. For circlips and screws we use a special zinc alloy, that is 8 times more salt resistant than zinc coating alone.

The features that make our Marine Upgrade so special are available but optional on all other models.

This makes all the umbrellas suitable for coastal areas.

Perfect for seaside locations or anyone who wants to extend the life of their umbrella.



SUITABLE FOR GARDEN  
& DINING AREAS



SUITABLE FOR  
COMMERCIAL GARDENS

# Membrane and Fabrics

**These membranes are cut on computer operated machines and sewn in-house by fully qualified and highly experienced staff. Only high-quality fabrics are used.**

Generally these membranes are equipped with special trims. For hems and seams on the fabric, Airtex trim is used throughout. By combining the colors of trim and fabrics, using related, contrasting or complementary colors, interesting color schemes can be achieved.

Alternatively, umbrellas can be designed to either blend into their surroundings or to a specific corporate color scheme. Adjustable, spring-loaded end pieces in the arms ensure automatic re-tightening of membranes as well as quick and easy cover changes.



## Sunacryl

The Sunacryl fabrics represents high effective sun protection. It is very durable against wind, weather, luminosity, heat and UV. Due to the solution dyed acryl fiber this fabric is non fading and tear resistant. Therefore Sunacryl is best suitable for your giant umbrella and is easy to clean.

### Specifications

- 100% acryl Sunacryl solution-dyed
- Cleanguard coating outdoor finish
- Weight 290 g/m<sup>2</sup>
- Colour fastness and UV resistance 7 to 8/8 (UV 801)
- Water pressure resistance 350 mm

## AIRTEX® classic (Polyester)

The AIRTEX® classic fabric is perfect for sun protection. This 200 g/m<sup>2</sup> light material is made of 100% polyester which comes with an acryl coating and impregnation on the upper side. The coating shows special textile character. AIRTEX® classic provides a very low surface weight and a good UV resistance. It is also water resistant and easy to clean.

### Specifications

- 100% polyester
- Acrylic finish on top side
- Weight 200 g/m<sup>2</sup>
- Colour fastness and UV resistance 6 to 8/8 (UV 801)
- Water pressure resistance 700 mm



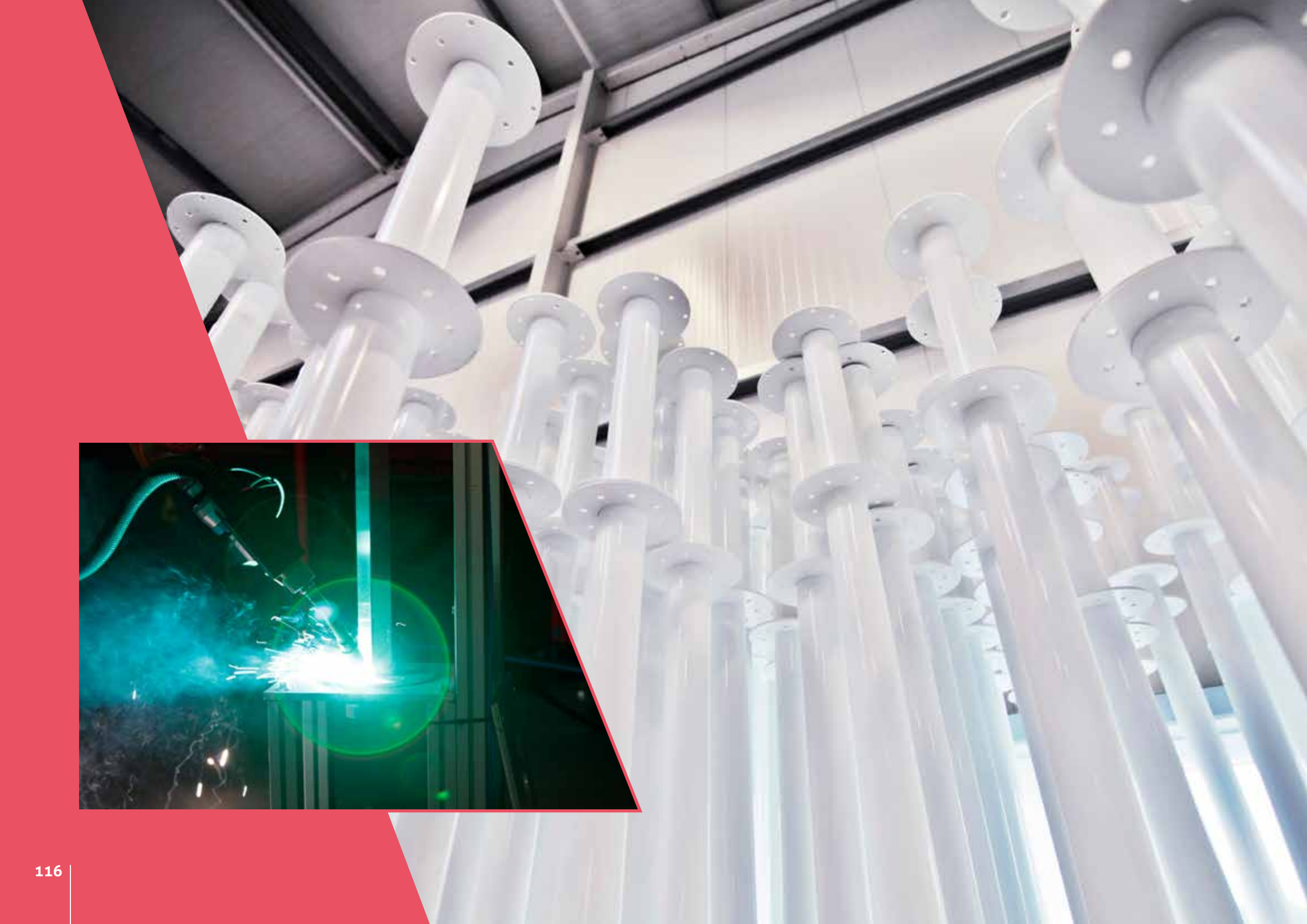

## Frame

**Our robust frames are renowned for their strength and durability. Depending on the size and type of umbrella, the extruded aluminium profiles are internally reinforced.**

All connecting components are manufactured from high quality stainless or galvanised steel. Each of the arms can be individually replaced. Spring-loaded end pieces located at the end of the arms to ensure automatic tightening of the membrane and facilitate membrane replacement.

The telescope is held securely by synthetic bearings to give stability. When closing the umbrella, the frame is raised, guaranteeing ample table clearance.



## Coating

**All aluminium profiles are finished with a high quality powder coating. This guarantees high scratch and impact resistance as well as protection against climatic and environmental influences.**

Besides our white standard coating, you can choose from any of the RAL colour selection or a pattern from our exclusive DECORAL® range, e.g. pine, walnut, oak, marble, granite, etc.

Please do not hesitate to ask for details. We will be happy to advise you.

**Coating thickness: 60 - 120 microns**  
**Colours: Any standard RAL colour**

## Decoral Coating

**This is a modified powder coating process for the imitation of lifelike surface motifs. Lots of natural decors (wood, stone, carbon, etc.) can be recreated through this procedure.**

The starting point and basic color of a Decoral coating is the regular powder coating. Now a special foil will be vacuumed onto this, which will be fixated at approximately 200 °C. This gives the material its special structure.

### Advantages:

- High weather resistance
- Highly decorative appearance
- Natural appearance with the highest corrosion protection
- Easy care compared to natural materials such as wood.



# Rain Gutters

**If you have a collection of Umbrellas or ones that are situated near buildings, then these can be easily connected by means of using rain gutters.**

When fitted these Gutter solutions provide weather protection to a much larger area allowing you more flexibility for your covered space.



Even detached umbrellas can be equipped with self-supporting gutters to allow rain water to drain off in desired directions. Airtex is used as the recommended material for our rain gutters. Their slightly conical shape provides the slope required to allow water to drain off efficiently.

For the necessary stability, our rain gutters have integrated aluminium profiles with threaded inserts.

The rain gutters are fastened to the end sections of the arms, using carabiners or special gutter adapters.



# Side Sheets

**Our side sheets make it possible to create a sheltered atmosphere and a cosy ambience.**

No matter if you are using an individual umbrella or a group of umbrellas connected.

Our side sheets are available with and without transparent clear vision inserts. The fastening system is identical to that of the rain gutters. Side sheets can be connected to one another by additional items. Roll-up doors are also available.

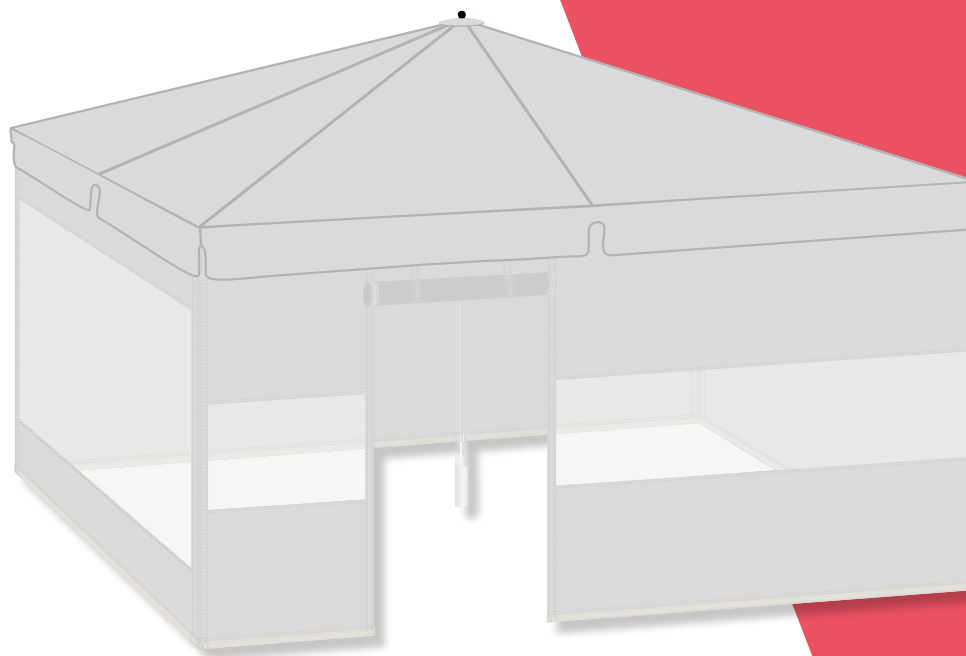

*Side sheet with clear vision, narrow  
(Clear vision: 0.68 m height)*

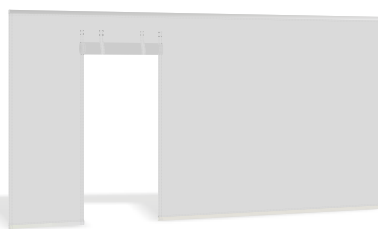

*Side sheet with door*



*Side sheet with clear vision, wide  
(Clear vision: 1.36 m height)*



*Continuous side sheet with skirting*



# Heating and Lighting

**As a high-end home owner, host or event manager, you are always keen on to provide your guests with a warm and welcoming atmosphere. With our heating and lighting solutions, you can turn your outdoor area into an impressive and pleasant location, for your guests to relax and feel at ease.**

Attaching energy saving light units and highly efficient infrared heaters to your

umbrella is not only friendly to the environment (compared to the use of conventional light bulbs and outdoor heaters), it will also save you money.

LED's can be implemented efficiently in a huge variety of applications such as road lighting, advertising, domestic lighting, and automotive lighting. They bear significant advantages over conventional lighting technologies and have become a part of our everyday life.

Our heater brackets are attached using special fixings. These can be conveniently collapsed before closing the umbrella. Time-consuming removal of the heaters is not necessary.





# Fixings

## In-ground and upper sleeve

For permanent installation, a 2 part fully galvanised ground sleeve system is recommended. The umbrella is firmly clamped and secured with an additional lock screw. The ground sleeve is set vertically and on ground level into a concrete foundation to ensure a secure standing position. In umbrellas with electrics, all cables are hidden from view inside the mast and the ground sleeve. The upper and inground sleeve is equipped with a hinge to ensure an easy installation and handling.

## Base Plate

The base plate is used in cases where a concrete foundation is not possible due to existing structural limitations. Prime examples are roof terraces, balconies, and locations with underlying basements, cellars or car parks. Safe and secure installation using a base plate is achieved by means of 8 anchor screws and heavy duty dowels. The upper and inground sleeve equipped with a hinge to ensure an easy installation and handling.

## Portable Stand

For mobile installations, we recommend our portable stand for use with concrete paving slabs. The four corner supports can be individually adjusted to compensate any unevenness in the ground. The upper and inground sleeve is equipped with a hinge to ensure an easy installation and handling.

## Characteristics

- Galvanised steel
- Powder coating in selectable color
- Long lasting and solid

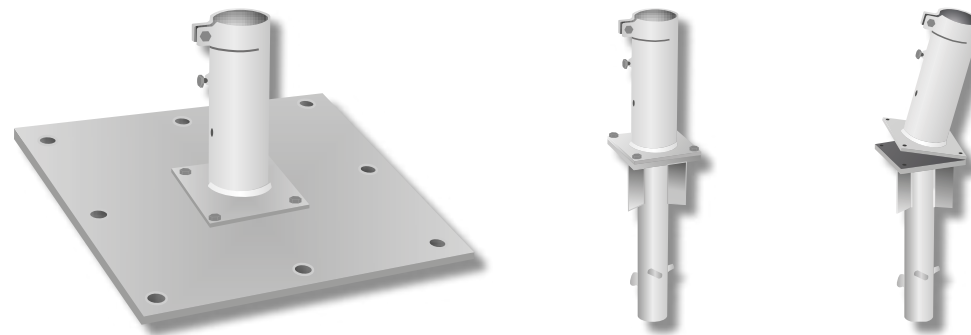
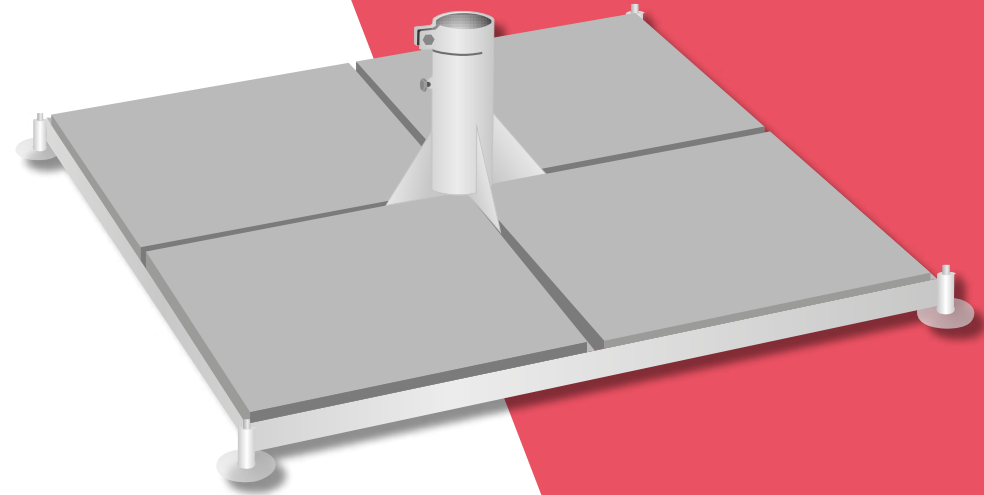



# Pavement *Banners*

We all love the look and ambience of continental cafés. The Pavement Banner windbreak system allows restaurant, bar and café operators to extend and define their sales areas and their outdoor sales season.

Indeed, establishments which protect their customers comfort with pavement banners can expect not only a longer season but also a greater spend per customer.

Our new Café pavement banners offer greater flexibility and ease of use. The system simply comprises standard uprights with a sturdy 10kg base and a choice

of 3 crossbar widths. All are completely interchangeable so you can mix and match to fit the venue perfectly.

Banners can be printed with your customers branding or plain in a choice of materials. We can provide full layout drawings and visuals for your site.

- **Corrosion free Stainless Steel**
- **Hardwear 10kg weighted bases**
- **Endlessly extendable**
- **1m, 1.5m & 2m widths as standard**
- **Bespoke systems available**

*"I love my new cafe windbreaks, they're just what I was looking for. I run a small coffee shop with outdoor seating for 20, so I needed a good product to stop mark out my sales area and stop the wind from blowing around! Top notch!"*

**DAN BOWLER**



Single Span System

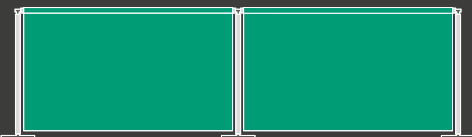

Twin Span System



Multi Span System





# Simplicity *Grass*

**As more people have busier lives, the time they used to spend on maintaining their lawns can now easily be put to better use. What's more, there needn't be any mud brought in from the garden on a rainy day, nor any bare patches during dry weather.**

Simplicity Grass is very easy to maintain, offers excellent drainage and is even pet-friendly. The biggest reason for its popularity though is the quality of the surfaces. Simplicity Grass now very closely resembles real turf in both its appearance and the way it feels underfoot.

All of our Simplicity lawns are designed for at least 10 years' use and will maintain their quality throughout all weather conditions.

## Specifications

<i>Yarn Type:</i>	100% UV Stabilised Monofilament Polyethylene /Texturised Polypropylene
<i>Colour:</i>	Green, Beige
<i>Pile Height:</i>	30mm
<i>Pile Weight:</i>	1450gsm
<i>Finished Weight:</i>	2190gsm
<i>Stitches:</i>	16,380 per sqm
<i>Tuft Gauge:</i>	5/16"
<i>Standard Width (+/-1.25%):</i>	4m
<i>Roll Length:</i>	Up to 30m
<i>Construction:</i>	Tufted
<i>Infill:</i>	Sand 4-6kg/sqm

## UV Stable

To ensure the longevity of our lawns, we use the highest UV Stabiliser in our fibres to minimise the effects of exposure to UV.

## Maintenance

Simplicity Grass will mean no longer having to remove muddy shoes, or have pets come in from the garden with muddy feet on a wet day. Looking after the lawn itself is also very simple.

Once installed, the lawn will largely take care of itself. It has excellent drainage and porosity, meaning that it can be laid in close proximity to water features with no fear of any drainage issues.

Any mess left by pets, or food dropped on the lawn can simply be hosed off. The surface is resistant to UV rays and is completely stain-resistant.



# Seamless *integration*



We understand if you are to resell our products, we need to make the integration into your business easy and simple. Otherwise it just won't work.

With that thought in mind, we have created a complete turnkey solution that is immediately available to you through our Trade Partner Area and from us. These services and materials are for you to retain for internal and external use and to enable staff training and development.

Services, Support documents and marketing materials include:



Example webpages





Milwood Training Academy



Promo Video Available



Complimentary Website



Technical Loadings Data



Case Studies



Product Samples



Surveyor Documents



Price Lists



Terms and Conditions



Installation Guides



Guarantee Documents



After Sales Pack



FRONT VIEW & ROOF TOP VIEW WITH BUILDING

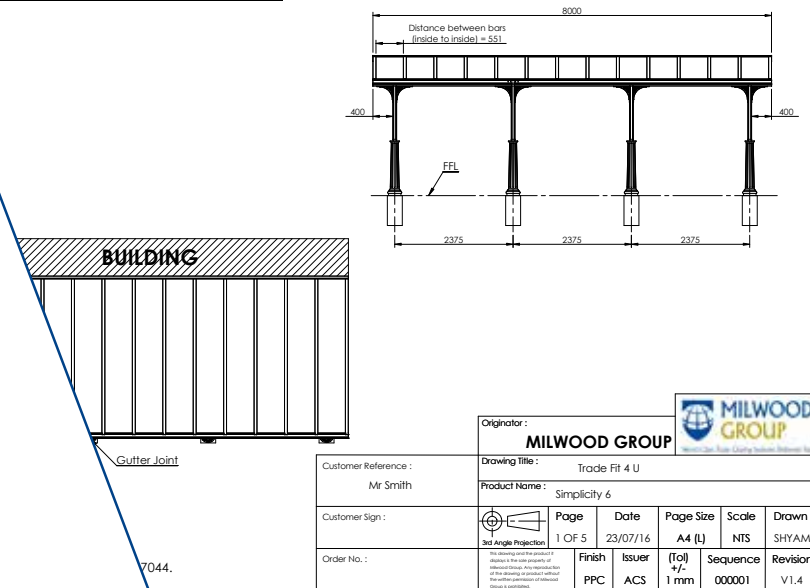

# How We Work

## *The 10 Step Guide*

We supply a detailed selection of technical data to enable your sales team to wow your customers with their knowledge and understanding of our products. Documents like the Snow & Wind Calculations, Pitch Charts, Quotation Templates, Case Studies and Brochures will all help to promote credibility at the right stage of the sales cycle.

Partner retention is the most important aspect of our business so the quality of our service and our products are THE most important thing to us. We focus on you, we constantly ask how we are doing and gather feedback on how we could do better, and at the same time we look to make the process of dealing with Milwood Group as easy as possible.



### Step 1

Qualify to become a Trade Partner in your area and train on our products and services.



### Step 2

Generate leads using our templates, knowledge, tips, templates and samples.



### Step 3

Price using our manual or online pricing package with guidance from our support team.



### Step 4

Quote using our quote templates, case studies and brochures.



## Step 5

Order using our easy to use step by step order process.



## Step 6

We produce a comprehensive 5 page CAD drawing to be signed of by you and your customer making things crystal clear.



## Step 7

We manufacture your goods right here in the UK and go through a rigorous 5 point check process.



## Step 8

We deliver your structures on our own vehicles direct to you whether you are on your customers site or at your own premises.



## Step 9

We call you to make sure you have everything you need, and that you are happy with the products. Your feedback is always welcome.



## Step 10

You then pass the guarantees and Aftersales Packs onto your customers so they know exactly how to care for their products.





# Glass and Glazing Federation (GGF)

**We are pleased to announce that we are members of the Glass and Glazing Federation (GGF).**

The Glass and Glazing Federation is the representative body for companies that make, supply or fit, glass and glazing products including double glazing and conservatories. The Glass and Glazing Federation (GGF) is the industry's main trade federation. Formed in 1977, many GGF Member companies were founder-members and all new companies that join have to meet the high standards set by the GGF.

When you use a GGF Member you are guaranteed to be using a firm that:

1. Has financial stability and has been trading for a minimum of 3 years.
2. Has been vetted and has premises, products and employees fit for purpose.
3. Employs trained professionals to ensure your installation is to the highest technical standards as outlined by the GGF Glazing Manual written by the industry's leading experts.
4. Complies with the GGF Consumer Code of Good Practice which has strict requirements regarding the conduct

of Member companies and ensures they comply with all relevant consumer legislation. All GGF Member companies are audited on a regular basis to ensure their compliance.

5. Offers you free access to our Conciliation Scheme in the unlikely event of a dispute with a GGF Member company. Rest assured you will not be left alone - The GGF will help resolve the dispute and if it cannot be resolved (very rare), the Glazing Arbitration Scheme is there to help you reach resolution.
6. Offers you transferable warranties - Should you sell your property, you can advise the buyer that the guarantee can be transferred over to them by the Member Company who fitted your windows for a reasonable fee.





# British Blind and Shutter Association

**The British Blind and Shutter Association (BBSA) is the only national trade association for companies that manufacture, supply and install interior and exterior blinds, awnings, security grilles and shutters and associated motor and control systems.**

The Association takes a leading role to ensure high standards of product, service and fair trading throughout the trade. Each member must adhere to a Code of Practice and is kept updated with changes to standards, requirements and best practice via regular communications.

The BBSA has been instrumental in leading the campaign for safer window blinds in the UK via its Make It Safe campaign. Milwood Group is pleased to have our already high standards endorsed by our membership of BBSA.

If you are looking for blinds and shutters to control glare, reduce heat, help black out a bedroom or provide a shady haven over your patio it makes sense to talk to experienced professionals like Milwood Group, whose expertise has been independently recognised. As a BBSA member Milwood Group are used to providing advice to homeowners, as well as architects and specifiers as required, on the best solution for any solar shading problem.

Solar shading is increasingly being used to effectively control the internal environment of homes by helping to reduce heat gain in the summer and heat loss in the winter. Glazing is static whereas blinds are dynamic allowing the occupier to operate the blinds based on the prevailing environmental conditions. As this area of home comfort becomes more sophisticated it makes sense to talk to Milwood Group, a proud BBSA member.

Milwood Group are used to providing advice to Trade Partners, as well as architects and specifiers as required, on the best solution for any solar shading problem.



We are proud members of The British Blind & Shutter Association (BBSA) the only UK trade association for blinds, shutters and associated services.



## Product Configurator

Compare the features of our flexible Simplicity Systems and other products to see what matches your customer's requirements for glass rooms, carports, canopies, verandas, awnings and pergolas.

Product Range	The Alfresco Range	Simplicity 6	Simplicity 16	Simplicity 35	Bioclimatic Pergolas	Awnings	Retractable Verandas	Umbrellas
All Aluminium System	✓	✓	✓	✓	✓	✓	✓	✓
Maximum Projection	6 metres	3.2 metres	4 metres	6 metres	Variable depending on orientation of Louvers	3.6 metres	5 metres	Up to 7.5 metres
Maximum Length	Unlimited	Unlimited	Unlimited	Unlimited	Unlimited	12 metres	Unlimited	Up to 7.5 metres
Roof Panel Material	8mm Toughened Glass	6mm Toughened Glass	16mm Polycarbonate	35mm Polycarbonate	Aluminium	Fabric	Fabric	Fabric
Distance Between Posts	6 metres	3 metres	3 metres	3.5 metres	7 metres	N/A	5 metres	N/A
Internal Downpipes	✓	✓	✗	✗	✓	N/A	N/A	N/A
Available in Any Colour	✓	✓	✓	✓	9 frame colours Up to 3 blade colours	Frame 4 colours only Fabric multiple colours	Up to 7 frame colours Fabric multiple colours	Available in any RAL colour
Victorian Upgrade Facility	✗	✓	✓	✓	✗	N/A	N/A	N/A
Heaters Available	✓	✓	✓	✓	✓	N/A	N/A	✓
Lighting Compatible	✓	✓	✗	✓	✓	✓	✓	✓
Glass Room Available	✓	✓	✗	✗	✓	✗	✗	✗

# Seamless integration into your business

Glass Rooms, Alfresco Verandas,  
Carports, Canopies, Pergolas,  
Retractable Verandas, Awnings  
and Umbrellas



**Milwood Group** First Floor, South Wing, 1 James Whatman Court,  
Turkey Mill Business Park, Ashford Road, Maidstone, Kent , ME14 5PP  
0333 305 5272 | [sales@milwoodgroup.com](mailto:sales@milwoodgroup.com)

**Manufacturing warehouse and training academy address:**  
8 Jacknell Road, Dodwells Bridge Industrial Estate, Hinkley, LE10 3BS

[www.milwoodgroup.com](http://www.milwoodgroup.com)

September 2018



Glass and Glazing Federation



The Milwood Group is a member of the GGF and BBSA.